



THE UNIVERSE OF INSTALLATION

INDOORS MINI SPEAKER

User's Manual



CSB SERIES

www.show-pa.com



INDEX

1 SAFETY RELATED SYMBOLS

1 WARNING

2 IMPORTANT SAFETY INSTRUCTION

3 INTRODUCTION

3 CONTROL ELEMENTS

4 CONNECTION DESCRIPTION

6 INSTALLATION DESCRIPTION

8 BLOCK DIAGRAM

9 TECHNICAL SPECIFICATIONS

11 FREQUENCY RESPONSE DIAGRAMS

IMPORTANT!

Please read this manual carefully before operating this unit for the first time.

All rights reserved to SEIKAKU. All features and content might be changed without prior notice. Any photocopy, translation, or reproduction of part of this catalogue without written permission is forbidden. Copyright © 2009 SEIKAKU GROUP

SAFETY RELATED SYMBOLS





The symbol is used to indicate that some hazardous live terminals are involved within this apparatus, even under the normal operating conditions.



The symbol is used in the service documentation to indicate that specific component shall be only replaced by the component specified in that Documentation for safety reasons.

 Protective grounding terminal.

 Alternating current /voltage.

 Hazardous live terminal .

ON: Denotes the apparatus turns on.

OFF: Denotes the apparatus turns off, because of using the single pole switch, be sure to unplug the AC power to prevent any electric shock before you proceed your service.

WARNING: Describes precautions that should be observed to prevent the danger of injury or death to the user.



Disposing of this product should not be placed in municipal waste and should be separate collection.

CAUTION: Describes precautions that should be observed to prevent danger of the apparatus.

WARNING

• Power Supply

Ensure the source voltage matches the voltage of the power supply before turning ON the apparatus.

Unplug this apparatus during lightning storms or when unused for long periods of time.

• External Connection

The external wiring connected to the output hazardous live terminals requires installation by an instructed person, or the use of ready-made leads or cords.

• Do not Remove any Cover

There are maybe some areas with high voltages inside, to reduce the risk of electric shock, do not remove any cover if the power supply is connected.

The cover should be removed by the qualified personnel only.

No user serviceable parts inside.

• Fuse

To prevent a fire, make sure to use fuses with specified standard (current, voltage, type). Do not use a different fuse or short circuit the fuse holder.

Before replacing the fuse, turn OFF the apparatus and disconnected the power source.

• Protective Grounding

Make sure to connect the protective grounding to prevent any electric shock before turning ON the apparatus.

Never cut off the internal or external protective grounding wire or disconnect the wiring of protective grounding terminal.

• Operating Conditions

This apparatus shall not be exposed to dripping or splashing and that no objects filled with liquids, such as vases, shall be placed on this apparatus.



To reduce the risk of fire or electric shock, do not expose this apparatus to rain or moisture.

Do not use this apparatus near water. Install in accordance with the manufacturer's instructions. Do not install near any heat sources such as radiators, heat registers, stoves, or other apparatus (including amplifiers) that produce heat. Do not block any ventilation openings.

No naked flame sources, such as lighted candles, should be placed on the apparatus.

IMPORTANT SAFETY INSTRUCTIONS

- Read these instructions.
- Follow all instructions.
- Keep these instructions.
- Heed all warnings.
- Only use attachments/accessories specified by the manufacturer.

• Power Cord and Plug

Do not defeat the safety purpose of the polarized or grounding type plug.

A polarized plug has two blades with one wider than the other. A grounding type plug has two blades and a third grounding prong. The wide blade or the third prong are provided for your safety. If the provided plug does not fit into your outlet, consult an electrician for replacement of the obsolete outlet.

Protect the power cord from being walked on or pinched particularly at plugs, convenience receptacles, and the point where they exit from the apparatus.

• Cleaning

When the apparatus needs a cleaning, you can blow off dust from the apparatus with

a blower or clean with rag etc.

Don't use solvents such as benzol, alcohol, or other fluids with very strong volatility and flammability for cleaning the apparatus body. Clean only with dry cloth.

• Servicing

Refer all servicing to qualified personnel. To reduce the risk of electric shock, do not perform any servicing other than that contained in the operating instructions unless you are qualified to do so .

Servicing is required when the apparatus has been damaged in any way ,such as power supply cord or plug is damaged , liquid has been spilled or objects have fallen into the apparatus, the apparatus has been exposed to rain or moisture, does not operate normally, or has been dropped.

INTRODUCTION

CSB series is designed for indoor installation and most public address system. It provides quality performance and alternative three models, including passive speaker cabinet, speaker cabinet with transformer and active speaker cabinet. Furthermore, we offer optional metal rotatable mounting bracket, thus you can install CSB speaker on wall easily. This new compact speaker series meet every demands for restaurants, supermarket, shopping mall, pubs, and so on. Enjoy your CSB series speaker cabinet and make sure that read this manual carefully before operation.

CONTROL ELEMENTS

REAR PANEL

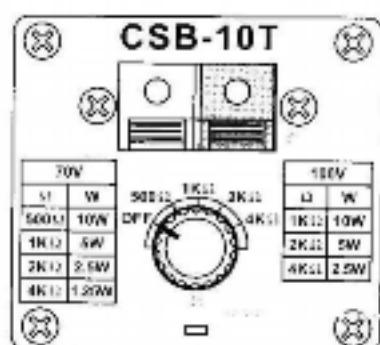

- (1) Input Connection
Use push-button for fixed installation.
The Positive connection is usually marked with (+), or Red push-button. Use it to connect the amplifier output (+).
The Negative connection is usually marked with (-), or Black push-button. Use it to connect the amplifier output (-).

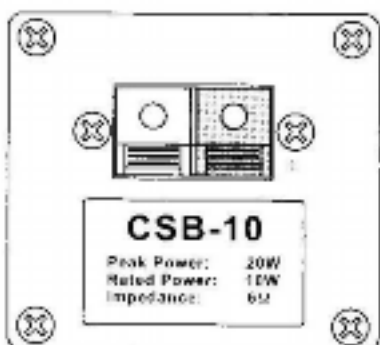

- (2) Power Selections
With this rotary switch, it is possible to select the power level of the CSB-10T/20T from 2.5W minimum to 20W maximum, for two different Constant Voltages 70V or 100V. In Off position the speaker system is disconnected from the Line.

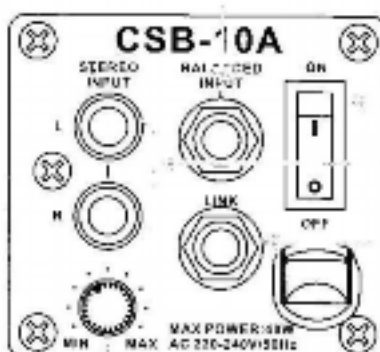

- (3) Balanced Input
Use this socket to input signal with a ϕ 6.3 cable.
- (4) ON/OFF switch
Use this switch to switch on/off power supply.
- (5) Stereo Input
It is used to input stereo signal.
- (6) LINK
It is used for outer signal output and be connected with other active speaker cabinets.
- (7) Volume Control
It is used to adjust the main volume.

(7)

CONNECTION DESCRIPTION

CONNECT ONE CSB PASSIVE MODEL TO ONE AMPLIFIER (FIGURE 1):

When the nominal impedance of the speaker you need to set up is 8Ω , then you should select and connect it to the amplifier terminal with 8Ω nominal impedance. Please notice that the speaker nominal impedance is no less than $3/4$ nominal impedance of amplifier output. Connect " 8Ω / + " of amplifier output to the red push button (+) of speaker and "com/-" of the amplifier to the black one (-) of the speaker.

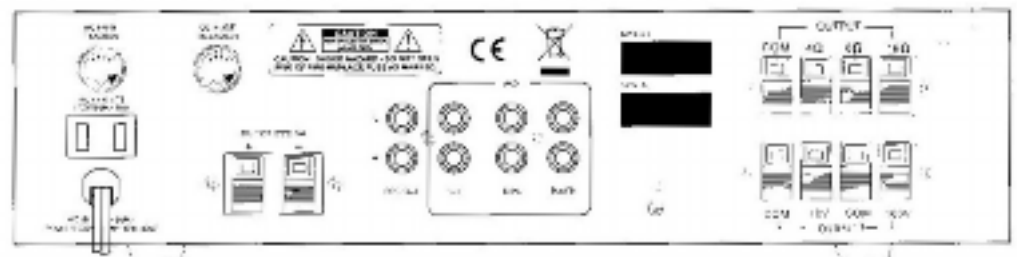

(Figure1)

CONNECT TWO OR MORE CSB PASSIVE MODELS TO ONE AMPLIFIER (FIGURE 2):

When two speakers with 8Ω nominal impedance are parallel, and the total impedance is 4Ω , then you should select and connect one of them to the amplifier terminal with 4Ω nominal impedance. Please notice that the total impedance of the paralleled speakers is no less than $3/4$ nominal impedance of amplifier output. Connect " 4Ω / + " of amplifier output to the red push button (+) of speaker and "com/-" of the amplifier to the black one (-) of the speaker.

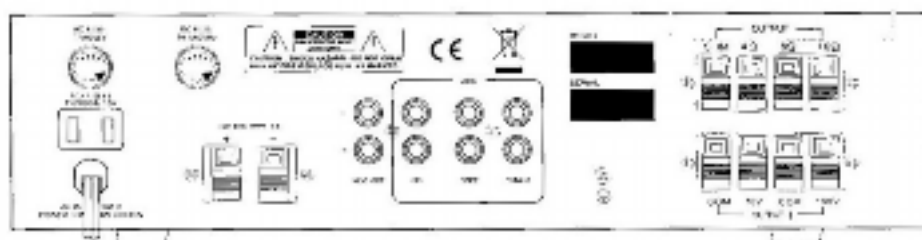
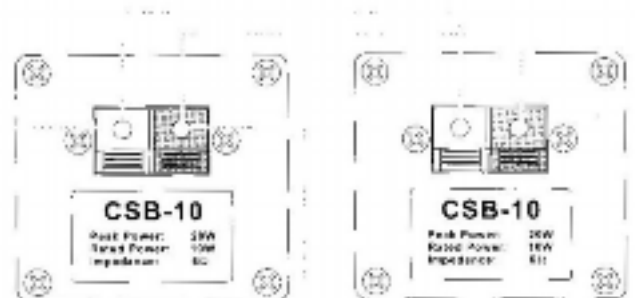

(Figure2)

LEVEL DISTRIBUTION SYSTEM (CSB "T" MODEL) CONNECTION DESCRIPTION:

Level distribution system only controls "T" model. CSB-10T and CSB-20T have built-in transformer of 70/100V, can connect many speakers to one channel, and only need one amplifier. The amplifier output terminal "com/-" stands for negative polar, terminal "70V/100V/+" stands for positive. The red speaker terminal stands for positive, black stands for negative. Please connect amplifier to speaker right, incorrect connection may cause damage to amplifier and speaker. Finally set your desired output power, see picture 3A to adjust the band switch to meet your need. In this case, the total power of all the speakers can't exceed the nominal power of amplifier. One 80W amplifier channel can drive 8 speakers of 10W, i.e. $10 \times 8 = 80 \leq 80W$. For safety, the total power of all the speakers should be less than 3/4 nominal power of amplifier (One 80W amplifier channel can drive 6 speakers of 10W, i.e. $10 \times 6 = 60W \leq 80W$).

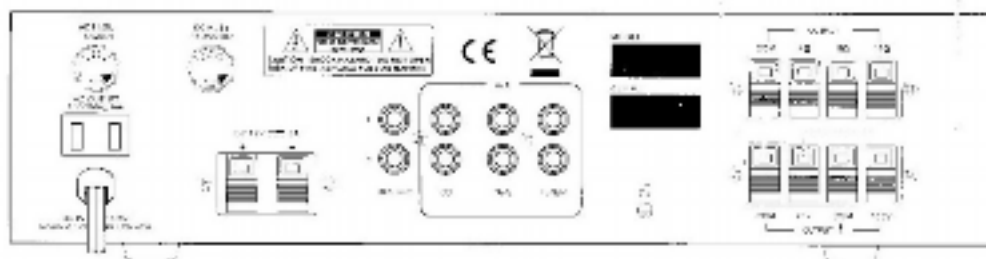

(figure3A)

6x10 WATT = 60 WATT TOTAL LOAD ON AMPLIFIER

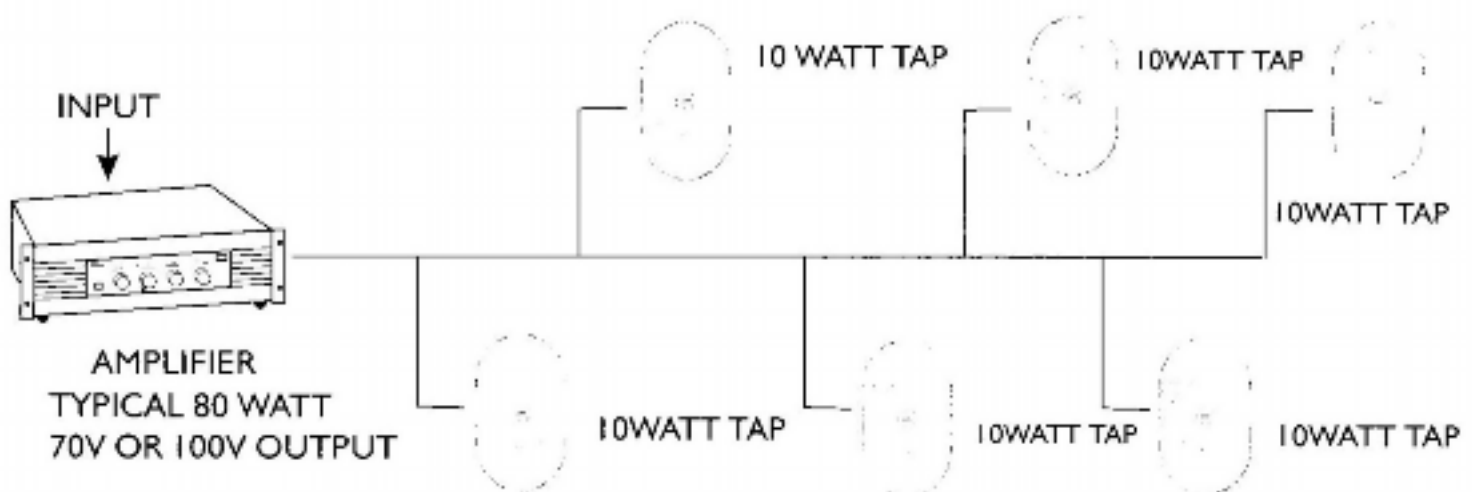

(figure3B)

INSTALLATION DESCRIPTION

Note: Commercial audio installation system must conform to local building laws. When install speaker on wall or ceiling, please consult a building constructor with a license or a professional engineer. The corporation won't be responsible for the improper installation or damage because of not conforming to installation description.

Installation procedure of CS-2 bracket is very simple and convenient, the appearance is pleasing to the eye.

Step 1: Fasten the CS-2 bracket(1) on the wall with screws. The wall material must support the weight of the cabinet.

Step 2: Place the body of cabinet in CS-2 bracket(2) and lock the screws tightly

Step 3: Use screw (3) lock CS-2 bracket(1) and CS-2 bracket(2), and use steel rope (4) to connect two brackets.

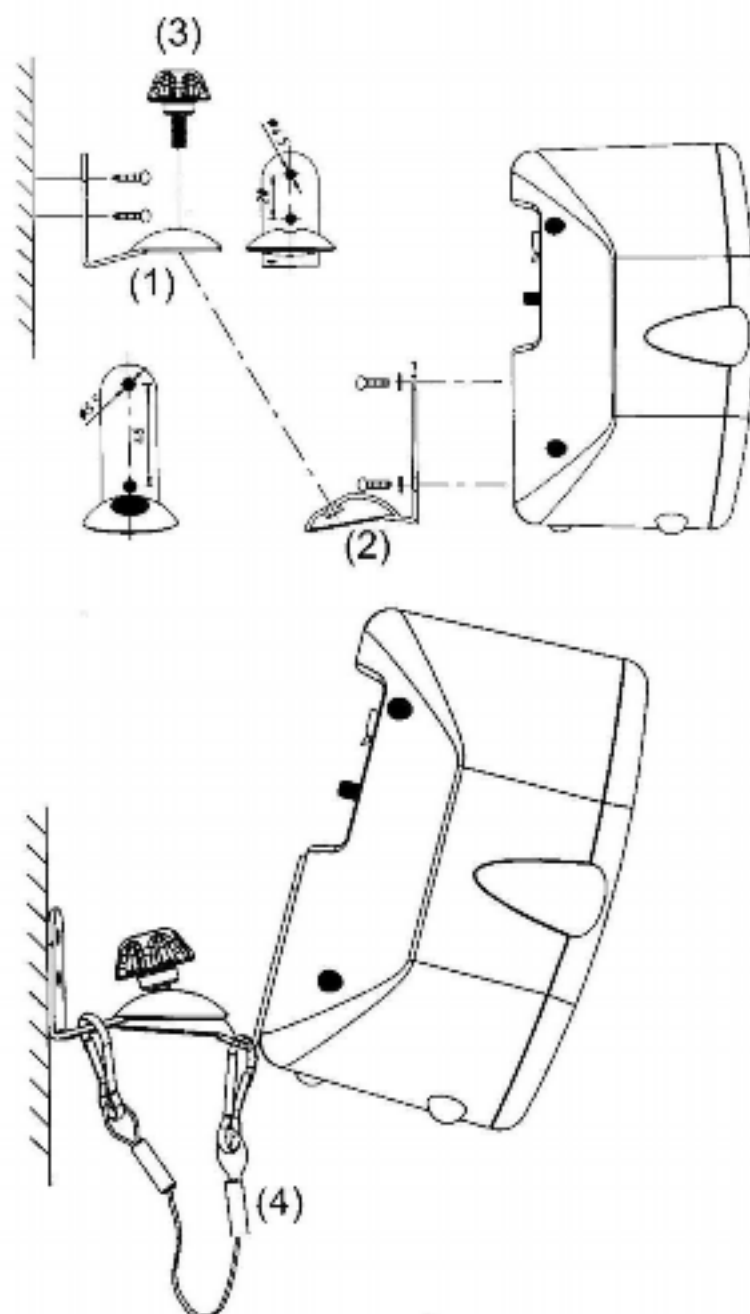

INDOOR INSTALLATION DESCRIPTION:

CSB series speakers are designed specially for fixing and using in different circumstances. The property of speakers may be different due to different circumstances. There is an acoustic surface (wall, floor and ceiling) in a closed room, so the acoustic indoor will turn complex. When acoustic wave hits the surface, a part of acoustic energy is reflected, and others are absorbed. Reflection and absorption are depending on the frequencies of acoustic wave and angle of hitting surface. When operate the cabinet, both man and furniture can absorb the acoustic energy. Please note the position of man and furniture when installing. Reverberation is the results of the reflected acoustic wave continue bouncing between the surfaces. Every reflection will loss the energy. When the acoustic hit the reflection surface, the room will be filled with random reflected acoustic wave. The music and address will be complex. It is recommended that install more speakers and make the volume of speakers lower to reduce the reverberation in high reverberating room. (Please see figure 5B)

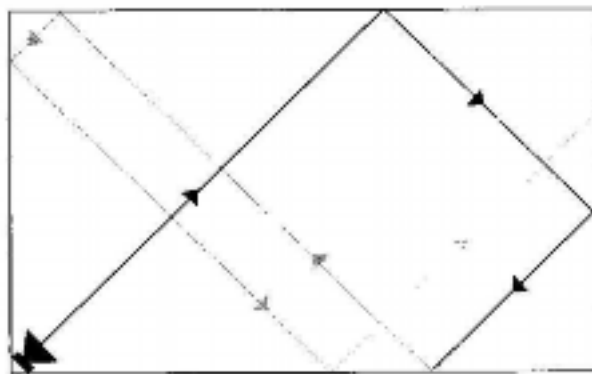

ONE LOUD SPEAKER
(figure5A)

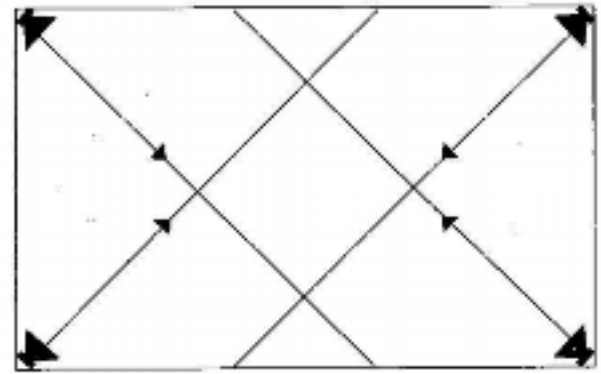

MULTIPLE QUIET SPEAKERS
(figure5B)

Speaker coverage range — Direct the center axile of the speaker to the flat surface of receiving area. The speakers of $90^\circ \times 90^\circ$ series can spread the speaker tone to all the directions at the axile of 45° . If you use the speakers in large room, you can divide the room to some zones. Then decide the installing location of the speakers. (Please see figure 6)

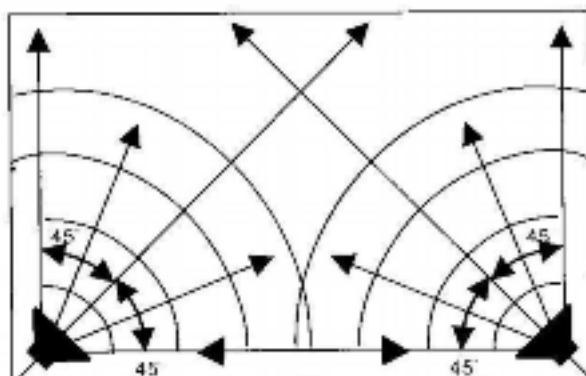

HORIZONTAL

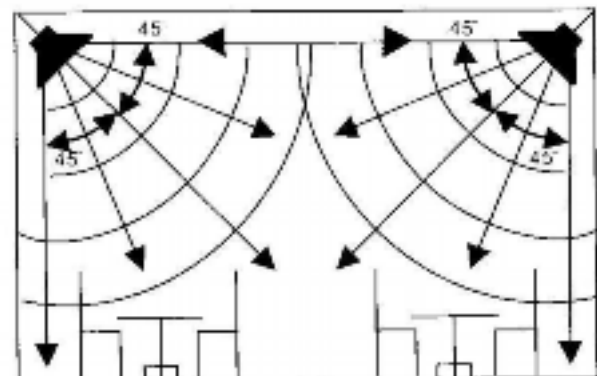



VERTICAL

(figure6)

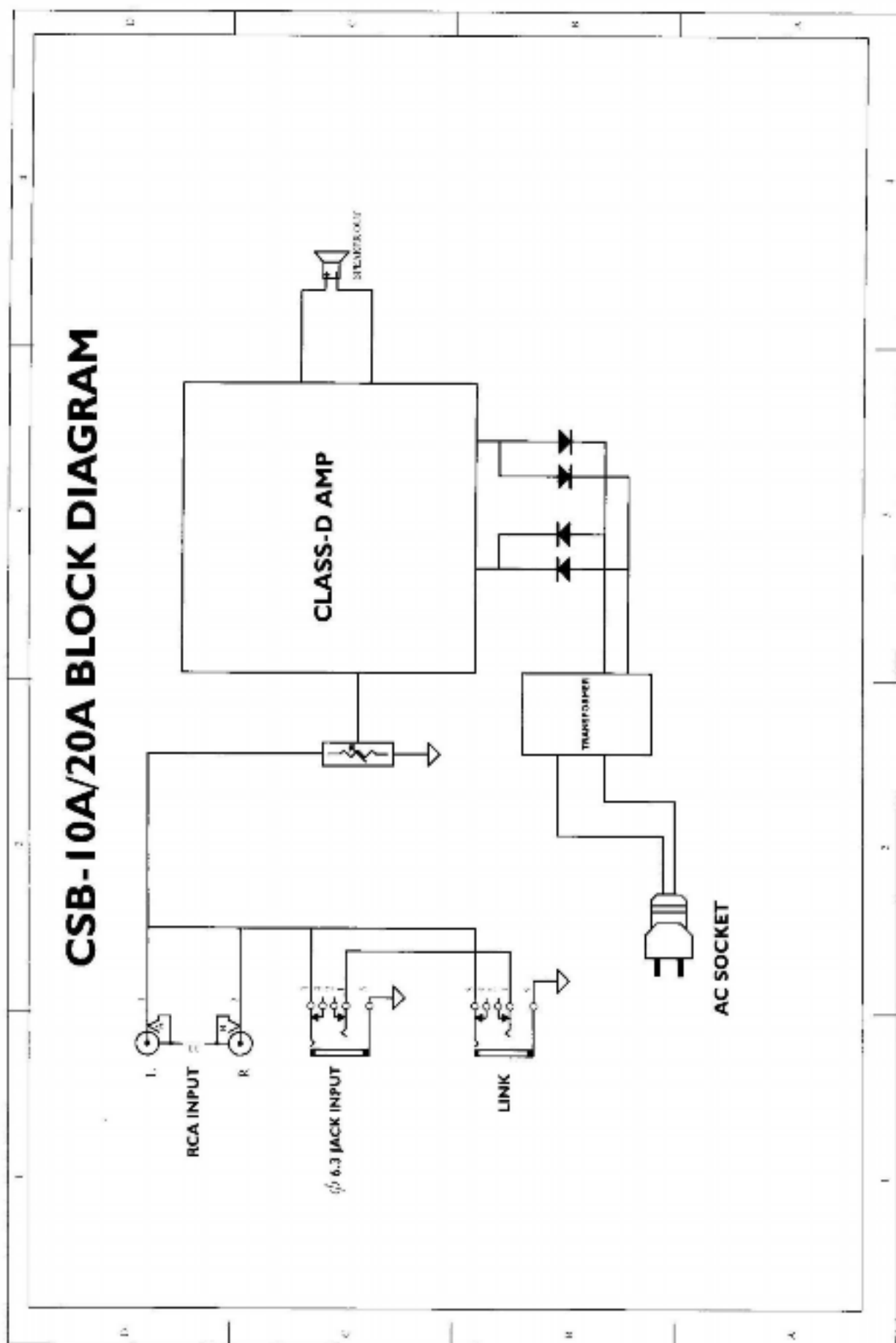

BLOCK DIAGRAM

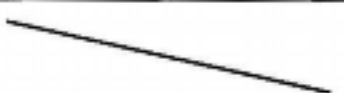

TECHNICAL SPECIFICATIONS

Model:	CSB-20	CSB-20T	CSB-20A
System Type:	Passive speaker cabinet	Speaker cabinet with transformer	Active speaker cabinet
Speaker:	3"(77*77mm)paper cone speaker	3"(77*77mm)paper cone speaker	3"(77*77mm)paper cone speaker
	0.8"(20.4mm)voice coil diameter	0.8"(20.4mm)voice coil diameter	0.8"(20.4mm)voice coil diameter
SPL at 1m/1w:	85 dB(\pm 3dB)	85 dB(\pm 3dB)	85 dB(\pm 3dB)
Frequency Response(-10dB):	132Hz-20KHz	132Hz-20KHz	132Hz-20KHz
Impedance:	6 Ω	70V 245 Ω /500 Ω /1K Ω /2K Ω	4 Ω
		100V 500 Ω /1K Ω /2K Ω	
Power Rating:	20W (RMS)	70V 20W/10W/5W/2.5W	20W (RMS)
		100V 20W/10W/5W	
Power Rating:	Wiring Terminal	Wiring Terminal	Input-RCA and ϕ 6.3 Balanced/Output-link ϕ 6.3 Jack
Connector:		Power selective switch	Volume control/ Power switch
External Controls:			220V-240V/50Hz 110V-120V/60Hz
Dimensions:	115*107*175mm	115*107*175mm	115*107*175mm
Weight:	0.8kg/1.76lbs	1.12kg/2.47lbs	1.342kg/2.96lbs



Model:	CSB-10	CSB-10T	CSB-10A
System Type:	Passive speaker cabinet	Speaker cabinet with transformer	Active speaker cabinet
Speaker:	3"(77*77mm)paper cone speaker	3"(77*77mm)paper cone speaker	3"(77*77mm)paper cone speaker
	0.5"(13mm)voice coil diameter	0.5"(13mm)voice coil diameter	0.5"(13mm)voice coil diameter
SPL at 1m/1w:	85 dB(±3dB)	85 dB(±3dB)	85 dB(±3dB)
Frequency Response(-10dB):	160Hz-20KHz	160Hz-20KHz	160Hz-20KHz
Impedance:	6Ω	70V 500Ω/1KΩ/2KΩ/4KΩ	4Ω
		100V 1KΩ/2KΩ/4KΩ	
Power Rating:	10W (RMS)	70V 10W/5W/2.5W/1.25W	10W (RMS)
		100V 10W/5W/2.5W	
Power Rating:	Wiring Terminal	Wiring Terminal	Input-RCA and φ 6.3 Balanced/Output-link φ 6.3 Jack
Connector:		Power selective switch	Volume control/ Power switch
External Controls:			220V-240V/50Hz 110V-120V/60Hz
Dimensions:	115*107*175mm	115*107*175mm	115*107*175mm
Weight:	0.514kg/1.134lbs	0.9kg/1.98lbs	1.06kg/2.34lbs

FREQUENCY RESPONSE DIAGRAMS

Audio Precision

CSB-10

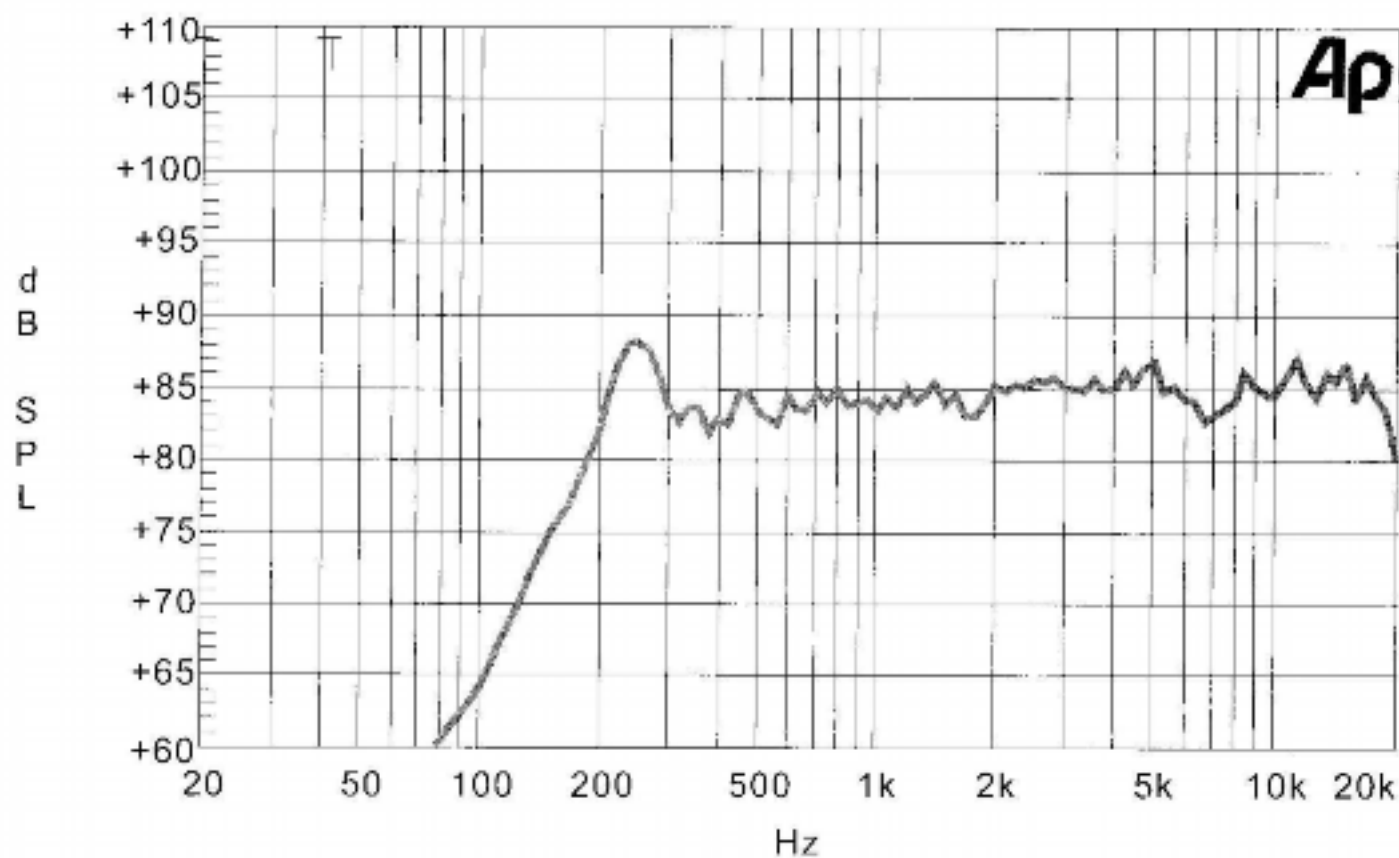

Audio Precision

CSB-10A

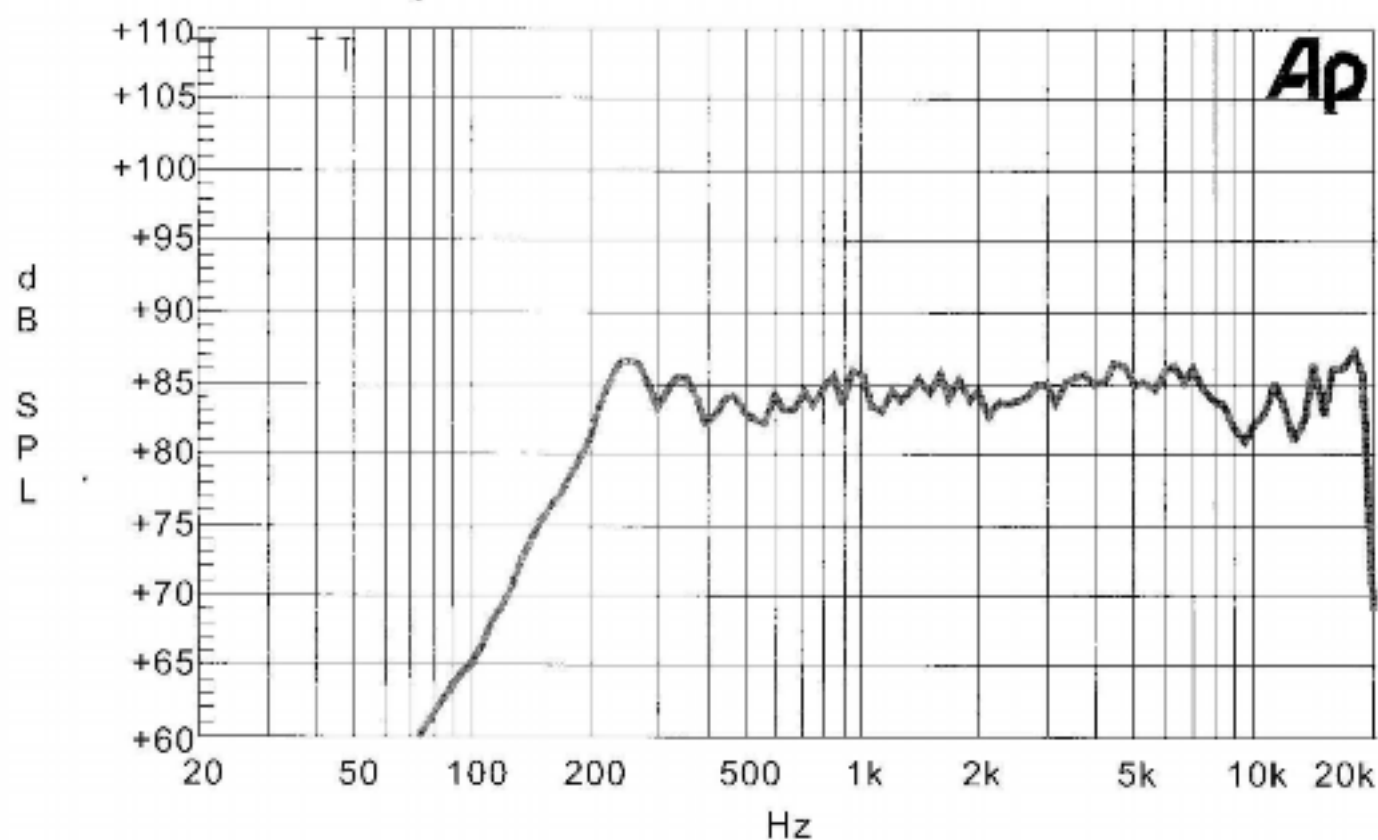



Audio Precision

CSB-10T

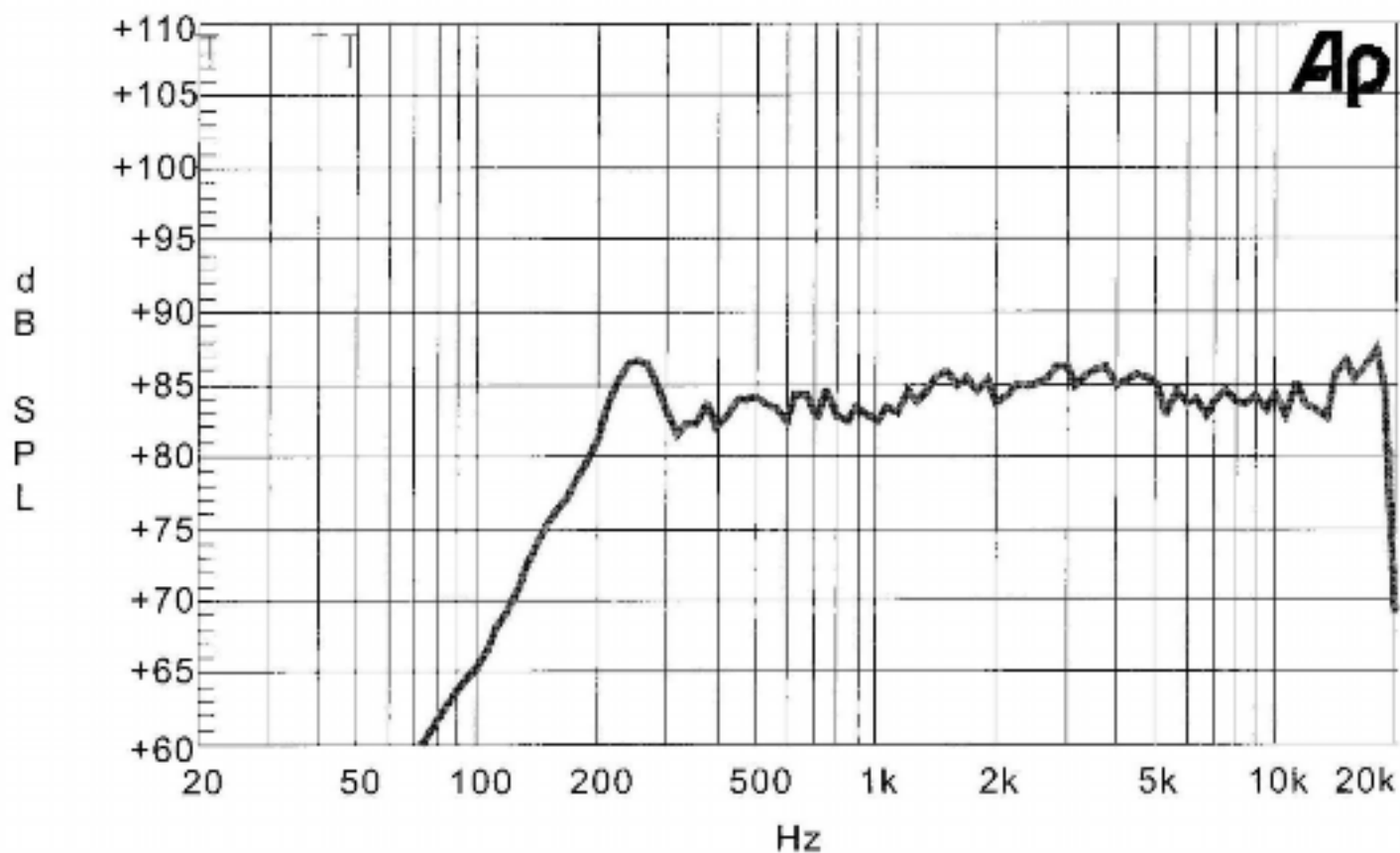

Audio Precision

CSB-20

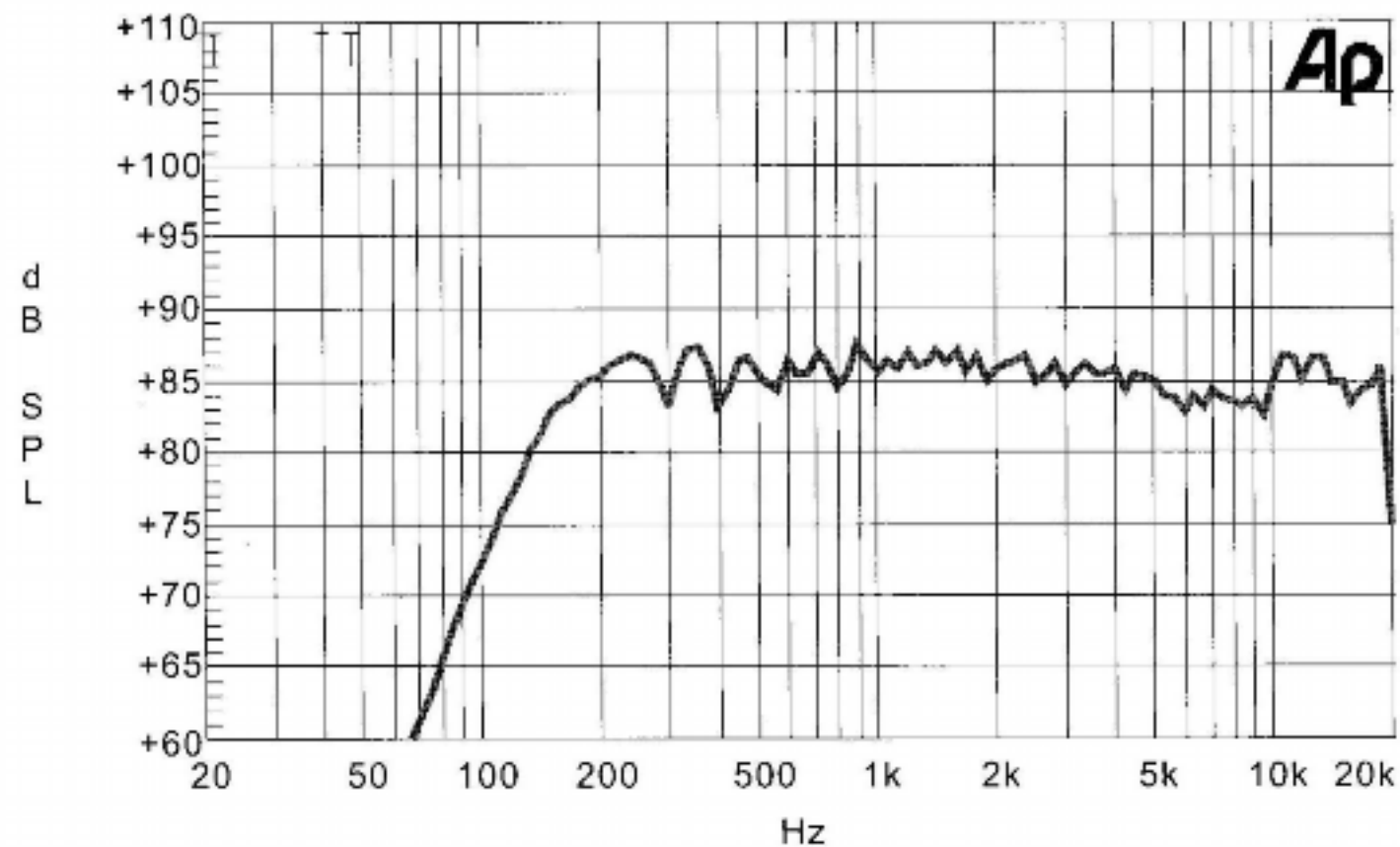

Audio Precision

CSB-20A

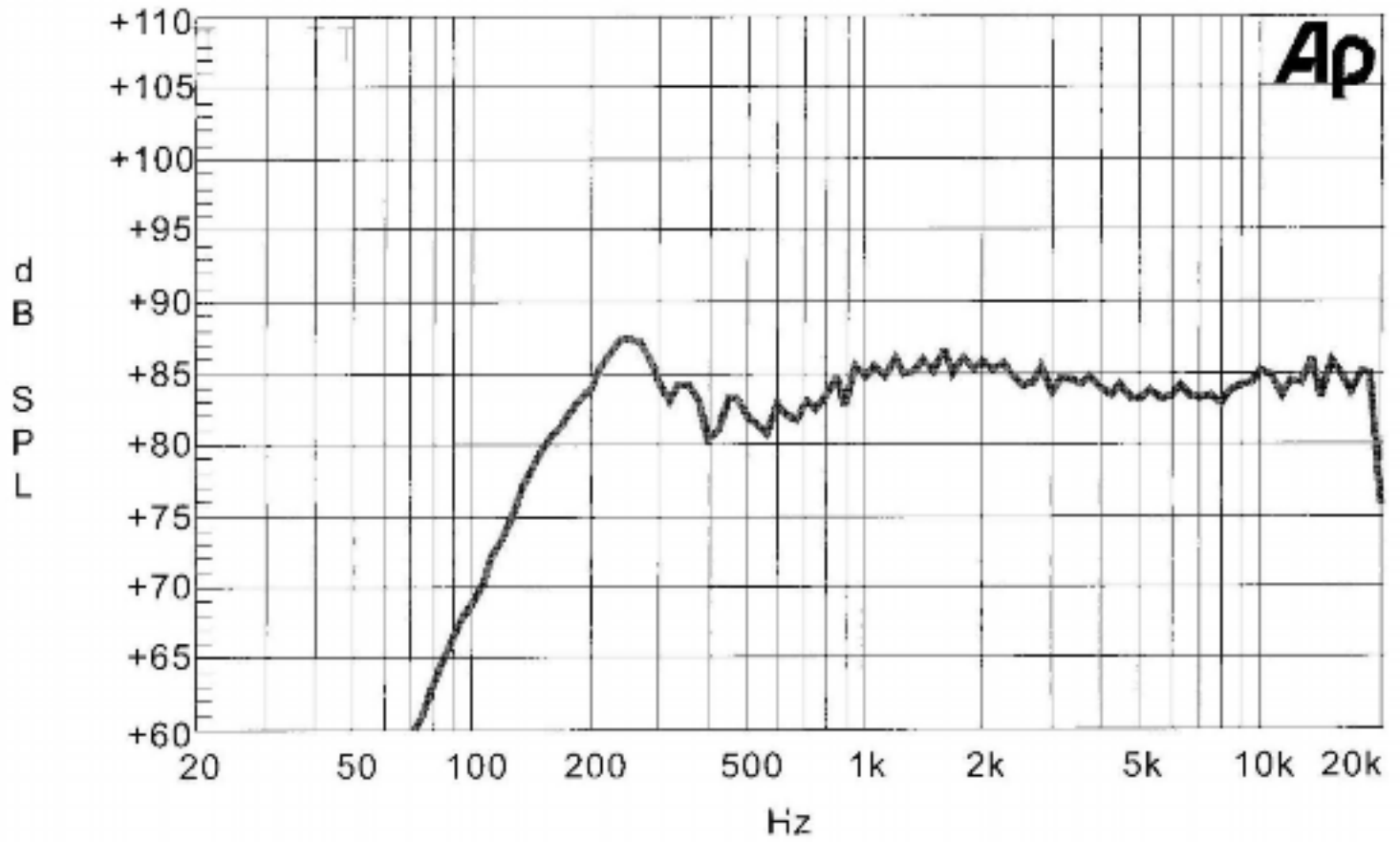

Ap

Audio Precision

CSB-20T

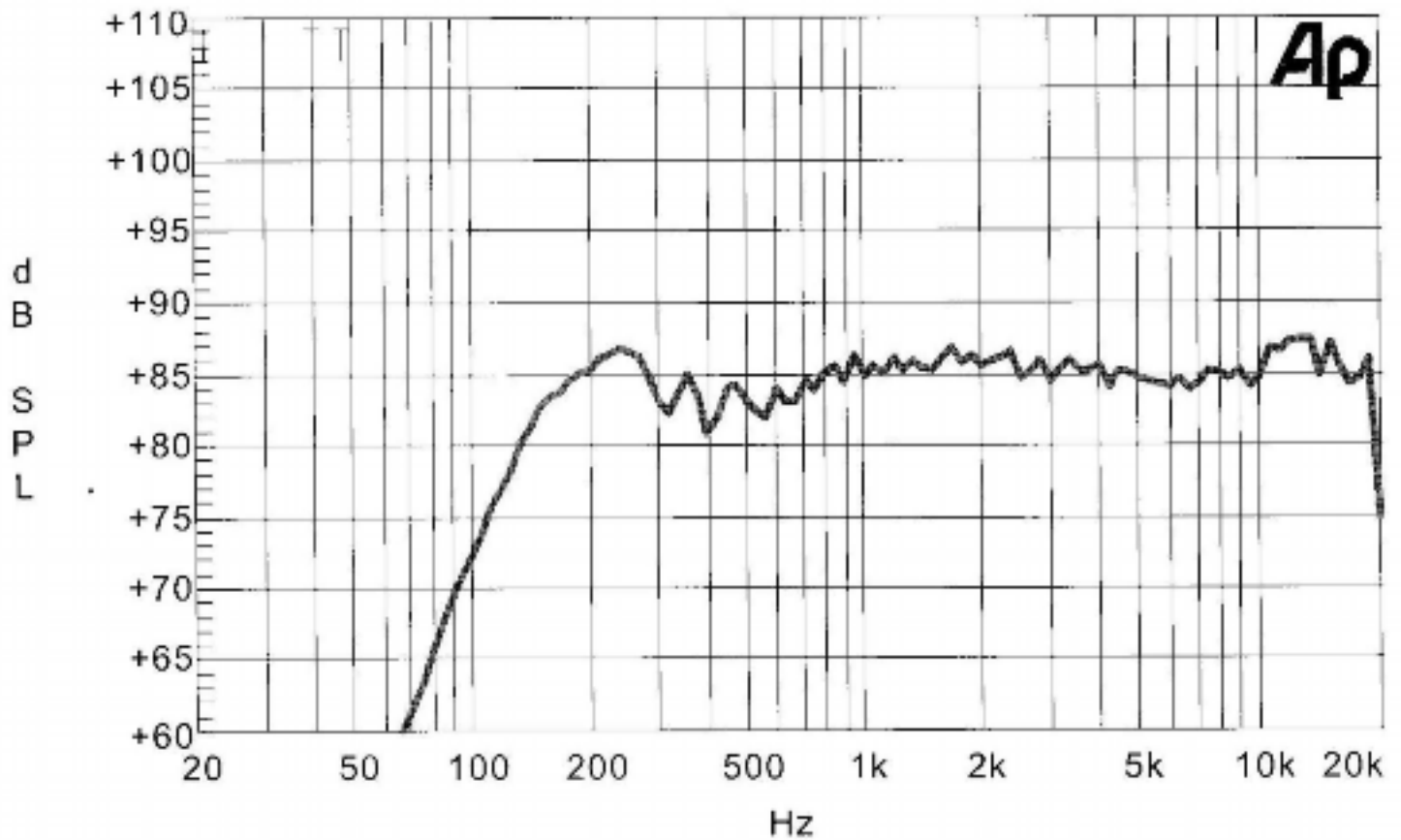

Ap



SHOW® is a registered trademark of
SEIKAKU TECHNICAL GROUP LIMITED

SEIKAKU TECHNICAL GROUP LIMITED

NO.1 LANE 17, SEC.2, HAN SHI WEST ROAD, TAICHUNG 40151, TAIWAN

tel: 886-4-22313737 - fax: 886-4-22346757