

SWITCHING POWER PROFESSIONAL AMPLIFIER

User's Manual

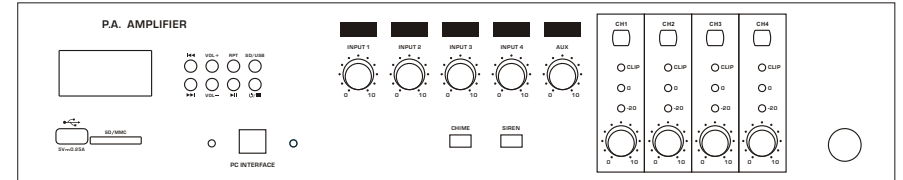

DA-241T/DA-241F

INDEX

01	SAFETY RELATED SYMBOLS	1
02	WARNING	1
03	IMPORTANT SAFETY INSTRUCTION	2
04	INTRODUCTION	3
05	CONTROL ELEMENTS	4
06	MP3 PLAYER	8
07	INTERFACE	9
08	CONFIGURATION EXAMPLE	18
09	BLOCK DIAGRAM	19
10	TECHNICAL SPECIFICATIONS	21

TECHNICAL SPECIFICATIONS

MODEL	DA-241T/DA-241F
Power supply :	AC 115V / 230V 50Hz / 60Hz
Power output (1kHz / 70V OR 100V):	DA-240T/DA-241T/DA-242T:RMS 240W*2 DA-240F/DA-241F/DA-242F:RMS 240W*4
INPUT / OUTPUT	DA-240T/DA-241T/DA-242T: 6 INPUT / 2 OUTPUT DA-240F/DA-241F/DA-242F: 6 INPUT / 4 OUTPUT
Frequency response:	MIC : 120Hz - 16kHz (±3dB) AUX : 120Hz - 16kHz (±3dB)
Inputs (balance / 1kHz) :	MIC (balanced) : -50dBv ± 2 dBv LINE (balanced) : -10dBv ± 2 dBv AUX (unbalanced) : -10dBv ± 2 dBv
THD+N (1K FULL POWER DOWN 3dB) :	<0.1%
S / N Ratio:	MIC : > 60 dB AUX : > 70 dB
CMRR (balance / 1kHz) :	>60dB
Crosstalk (1kHz) :	>60dB
Outputs :	70V / 100V switchable
LINE OUT:	1V ±0.2V
MOH.	1W @ 8Ω / 1V @ 600Ω
TEL. INPUT	-10dBv ± 2dBv
Dimension (W x D x H) :	434x353x88mm
Weight (Approx.) :	7.0kg 8.0kg

IMPORTANT!

Please read this manual carefully before operating this unit for the first time.

All rights reserved to SEIKAKU. All features and content might be changed without prior notice. Any photocopy, translation, or reproduction of part of this catalogue without written permission is forbidden. Copyright © 2009 SEIKAKU GROUP

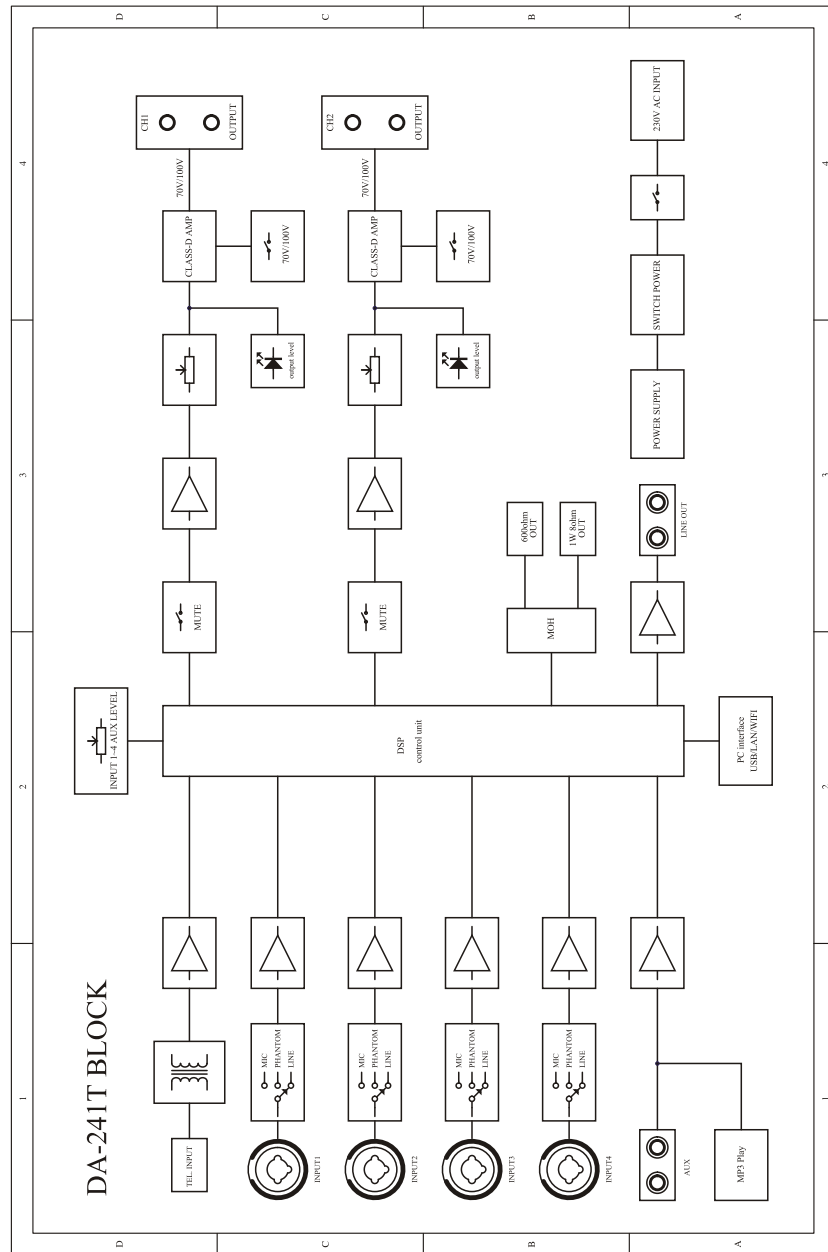

SAFETY RELATED SYMBOLS



The symbol is used to indicate that some hazardous live terminals are involved within this apparatus, even under the normal operating conditions.



The symbol is used in the service documentation to indicate that specific component shall be only replaced by the component specified in that Documentation for safety reasons.



Protective grounding terminal.



Alternating current /voltage.



Hazardous live terminal .

ON: Denotes the apparatus turns on.

OFF: Denotes the apparatus turns off, because of using the single pole switch, be sure to unplug the AC power to prevent any electric shock before you proceed your service.

WARNING: Describes precautions that should be observed to prevent the danger of injury or death to the user.



Disposing of this product should not be placed in municipal waste and should be separate collection.

CAUTION: Describes precautions that should be observed to prevent danger of the apparatus.

WARNING

• Power Supply

Ensure the source voltage matches the voltage of the power supply before turning ON the apparatus.

Unplug this apparatus during lightning storms or when unused for long periods of time.

• External Connection

The external wiring connected to the output hazardous live terminals requires installation by an instructed person, or the use of ready-made leads or cords.

• Do not Remove any Cover

There are maybe some areas with high voltages inside, to reduce the risk of electric shock, do not remove any cover if the power supply is connected.

The cover should be removed by the qualified personnel only.

No user serviceable parts inside.

• Fuse

To prevent a fire, make sure to use fuses with specified standard (current, voltage, type). Do not use a different fuse or short circuit the fuse holder.

Before replacing the fuse, turn OFF the apparatus and disconnected the power source.

• Protective Grounding

Make sure to connect the protective grounding to prevent any electric shock before turning ON the apparatus.

Never cut off the internal or external protective grounding wire or disconnect the wiring of protective grounding terminal.

• Operating Conditions

This apparatus shall not be exposed to dripping or splashing and that no objects filled with liquids, such as vases, shall be placed on this apparatus.

To reduce the risk of fire or electric shock, do not expose this apparatus to rain or moisture.

Do not use this apparatus near water. Install in accordance with the manufacture-r's instructions. Do not install near any heat sources such as radiators, heat registers, stoves, or other apparatus (including amplifiers) that produce heat. Do not block any ventilation openings.

No naked flame sources, such as lighted candles, should be placed on the apparatus.

IMPORTANT SAFETY INSTRUCTIONS

- Read these instructions.
- Follow all instructions.
- Keep these instructions.
- Heed all warnings.
- Only use attachments/accessories specified by the manufacturer.

• Power Cord and Plug

Do not defeat the safety purpose of the polarized or grounding type plug.

A polarized plug has two blades with one wider than the other. A grounding type plug has two blades and a third grounding prong. The wide blade or the third prong are provided for your safety. If the provided plug does not fit into your outlet, consult an electrician for replacement of the obsolete outlet.

Protect the power cord from being walked on or pinched particularly at plugs, convenience receptacles, and the point where they exit from the apparatus.

• Cleaning

When the apparatus needs a cleaning, you can blow off dust from the apparatus with

a blower or clean with rag etc.

Don't use solvents such as benzol, alcohol, or other fluids with very strong volatility and flammability for cleaning the apparatus body. Clean only with dry cloth.

• Servicing

Refer all servicing to qualified personnel. To reduce the risk of electric shock, do not perform any servicing other than that contained in the operating instructions unless you are qualified to do so .

Servicing is required when the apparatus has been damaged in any way , such as power supply cord or plug is damaged , liquid has been spilled or objects have fallen into the apparatus, the apparatus has been exposed to rain or moisture, does not operate normally, or has been dropped.

The mains plug is used as the disconnect device, the disconnect device shall remain readily operable.

BLOCK DIAGRAM

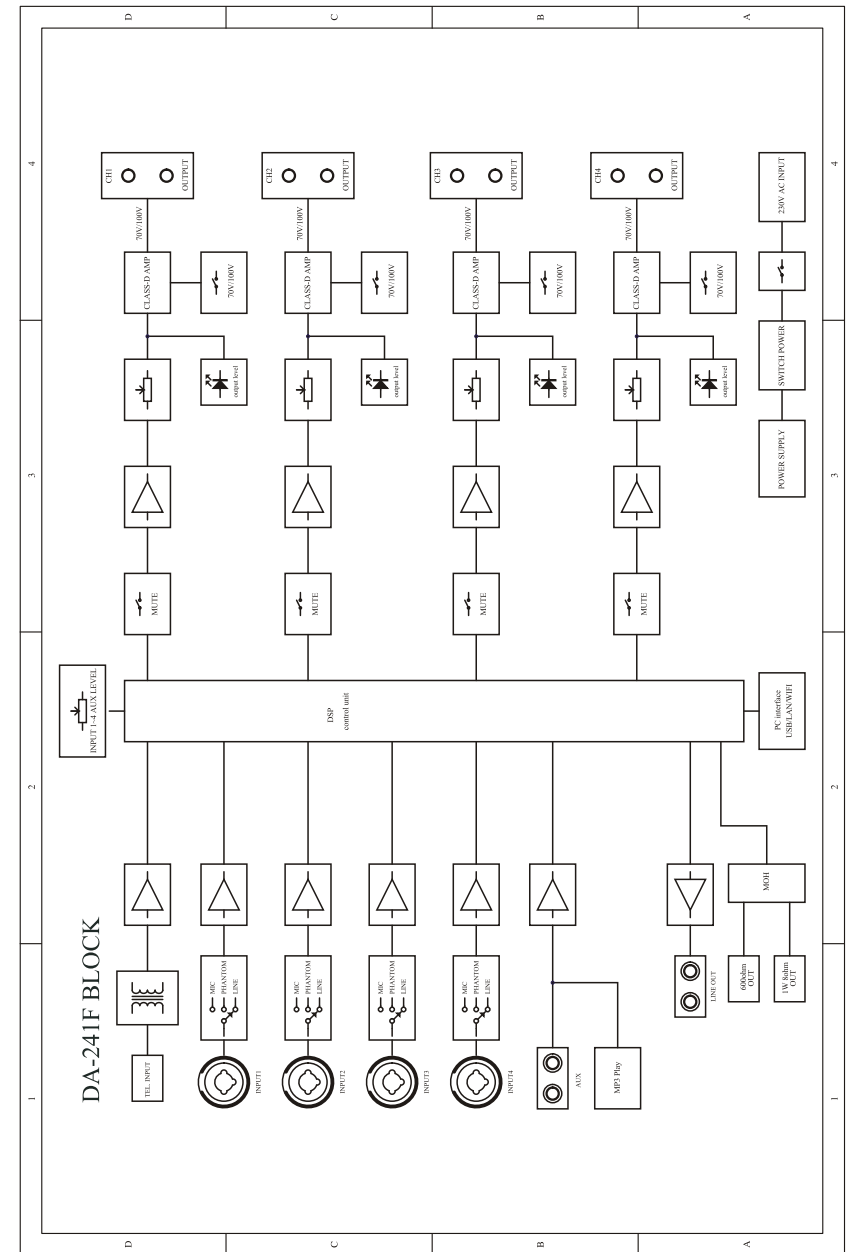

CONFIGURATION EXAMPLE

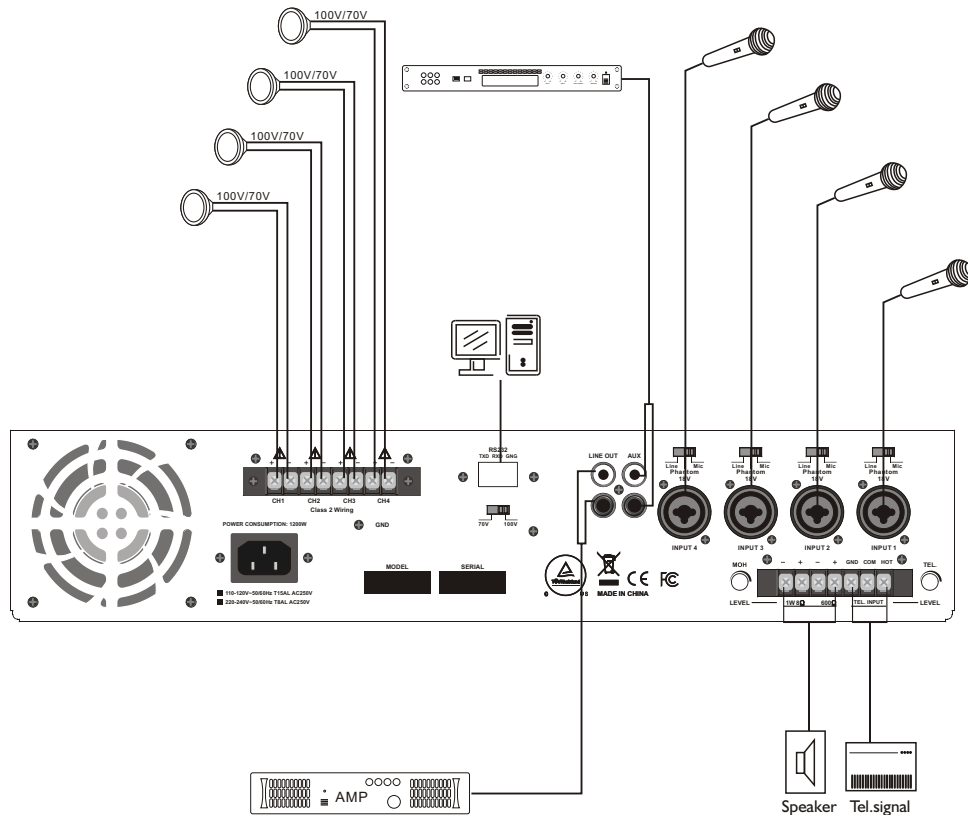

INTRODUCTION

Switching power professional Amplifier is designed for professional use on stage. The high-quality components and the carefully designed circuits ensure excellent audio performance and an extremely linear frequency response. In fact, the switching technology offers, together with an increased efficiency and a better control of heat dissipation than conventional power supply systems, a drastic reduction of dimensions and weight, for easier transportation and installation. This Amplifier guarantees total reliability and a trouble-free use even in the most demanding conditions. We believe this product will provide a perfect performance, what you get is unprecedented performance at an incredibly attractive price.

Features:

- *High current switching power allowing high power output with low noise and low distortion
- *Substantial protection circuitry like thermal, short circuit, output DC offset, power on/off muting and Therefore protection
- *Built-in limiter
- *Balanced XLR-TRS combo input jack
- *Speakon output connectors
- *front mounted gain controls for easy access
- *Signal, Clip protect, Parallel mode, and Power LED indicators to monitor performance.

under the EM disturbance, the ratio of signal-noise may be changed above 3dB.

This device complies with Part 15 of the FCC Rules. Operation is subject to the following two conditions: (1) this device may not cause harmful interference, and (2) this device must accept any interference received, including interference that may cause undesired operation.

FCC Statement:

"This equipment has been tested and found to comply with the limits for a Class B digital device, pursuant to part 15 of the FCC Rules. These limits are designed to provide reasonable protection against harmful interference in a residential installation. This equipment generates, uses and can radiate radio frequency energy and, if not installed and used in accordance with the instructions, may cause harmful interference to radio communications. However, there is no guarantee that interference will not occur in a particular installation. If this equipment does cause harmful interference to radio or television reception, which can be determined by turning the equipment off and on, the user is encouraged to try to correct the interference by one or more of the following measures:

- Reorient or relocate the receiving antenna.
- Increase the separation between the equipment and receiver.
- Connect the equipment into an outlet on a circuit different from that to which the receiver is connected.
- Consult the dealer or an experienced radio/TV technician for help."

CONTROL ELEMENTS

FRONT PANEL

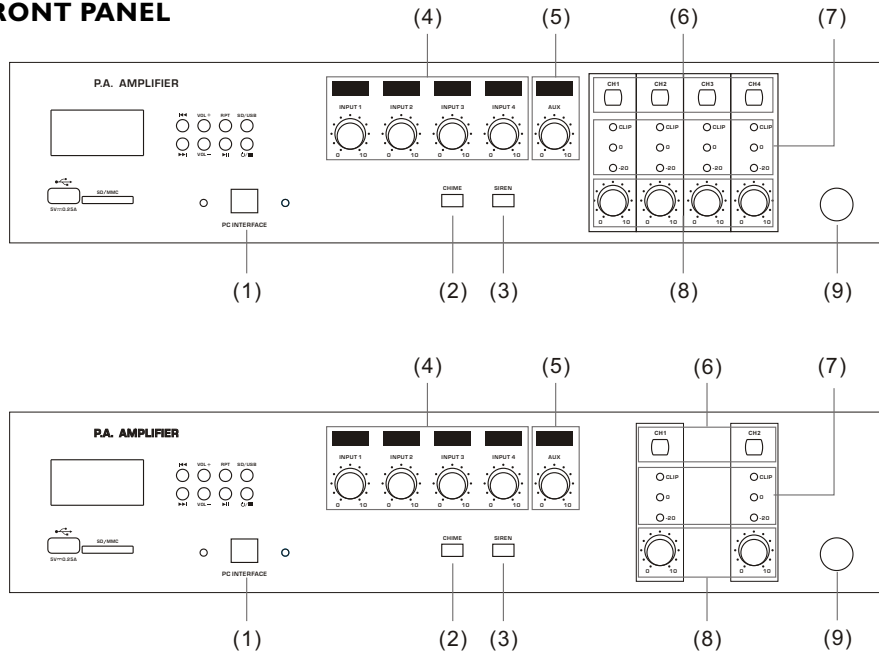

(1) PC INTERFACT

Connect computer to update the programming of product

(2) CHIME switch

The CHIME will appear after pressing the switch and the CHIME can be adjusted by the control knob of MASTER

(3) SIREN switch

The SIREN will appear after pressing the switch

(4) INPUT 1 ~4 VOL KNOBS

The knobs are use to dajust the gain of input 1 ~4 respectively. Adjust clockwise to increase the volume while adjust counter-clockwise to decrease the volume

(5) AUX VOL knob

The knobs are use to dajust the gain of AUX . Adjust clockwise to increase the volume while adjust counter-clockwise to decrease the volume

1. The name of the input and output can be changed, press the Enter key to confirm the change, that means the modification is successful.

All the changed names will be updated to the main page and all sub-pages.

2. Click "Reset To Default Setting" to restore all parameters to default settings,

Excludes all changeable names and presets which are saved to the machine.

3. Click "Reset To Factory Setting" to restore all parameters to default settings,

And restore all changeable names and presets to factory settings.

4. Adjust the value in "Priority" to change the priority of the channel; adjust the value in "Priority Gain" to change the priority.

Priority: The channel with the highest priority can be output normally. It is not affected by the value in priority gain. The output of other channels will attenuate the value in the priority gain. When there is no input of the highest priority channel, the second highest channel will be output normally.

Value in Priority gain: When the channel with the highest priority and there is input, the output of other channels will attenuate the value in the priority gain.

5. Change the displaying language via "Language".

3. Save and read preset parameters

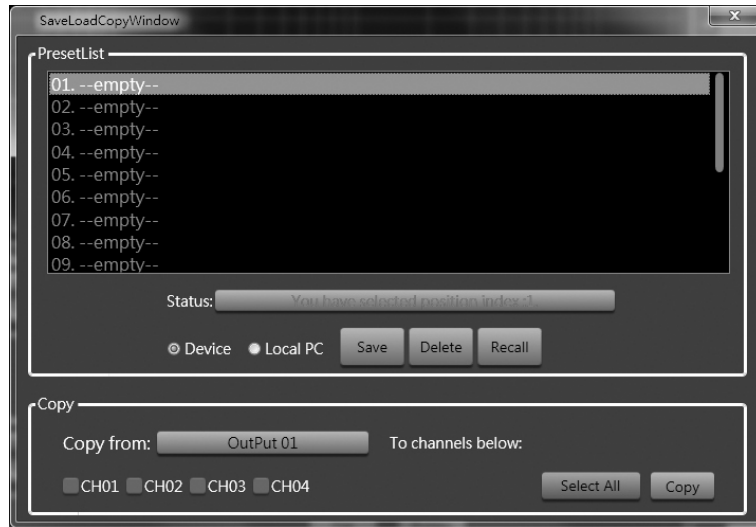

When tick the "Device" below,

- (1) Press "Save" to save the parameters to the preset list,
- (2) Press "Delete" to delete the preset saved in the preset list,
- (3) Press "Recall" to export the preset parameters from the preset list,

When tick the " Local PC " below,

- (1) Press "Save" to export parameters to the local,
- (2) Press "Load" to import the default parameters from the local,

After checking CH01~04, press "Copy" to copy the current channel parameters to the selected channel.

4. System parameter setting

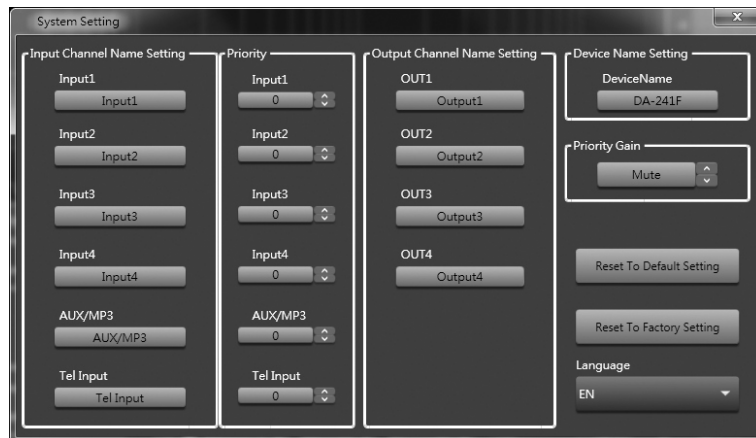

(6) CHI ~4 PAGING SELECTOR

There are four zone paging controls and one mains zone paging control. Press CHI ~4 keys the output terminal in front panel have respectively output

(7) Output level indicator LED

(8) OUTPUT CHI ~4 VOL KNOBS

The knobs are used to adjust the gain of OUTPUT CHI ~4 respectively. Adjust clockwise to increase the volume while adjust counter-clockwise to decrease the volume

(9) POWER SWITCH

The main power can be switched on or off with it

REAR PANEL

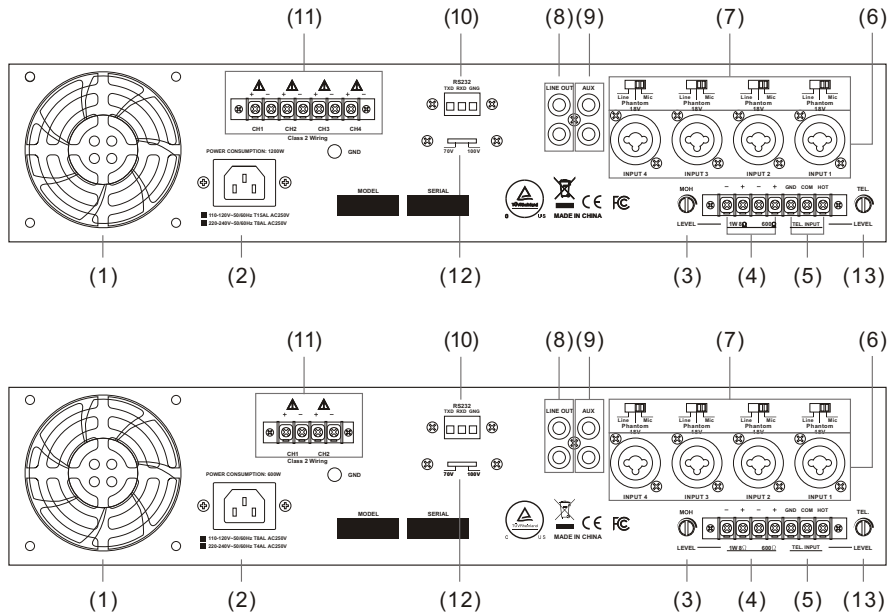

(1) FAN

It is the constant rotation

(2) AC JACK

This connector is meant for connection of supplied main cord. Do not insert the power cord into this unit until voltage has been correctly set

(3) MUSIC ON HOLD VOL

It is used to monitor volume of black ground music

(4) MUSIC ON HOLD OUTPUT

It is connected to monitor the signal of aux input

(5) TELEPHONE PAGING

It is connected with telephone

(6) INPUT 1~4

They are used for both balanced and unbalanced inputs.

(7) MIC/PHANTOM/LINE SELECT SWITCH

It is turned to left for MIC, middle for PHANTOM, and right for LINE

(8) LINE OUT

It is connected to recorder and pass on mixed signal

(1) Adjust the input volume here.

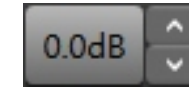

(2) Input and output selection, click the first small box to the right of the input module, the default connection is the output 1, and so on.

You can also click the input module to pull a line to the output which you want to route. Each I / O module can be moved.

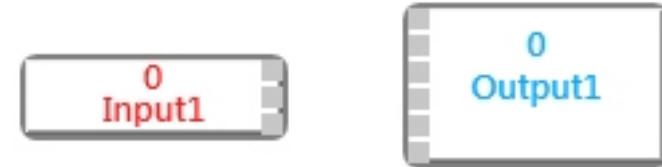

2. Effect setting

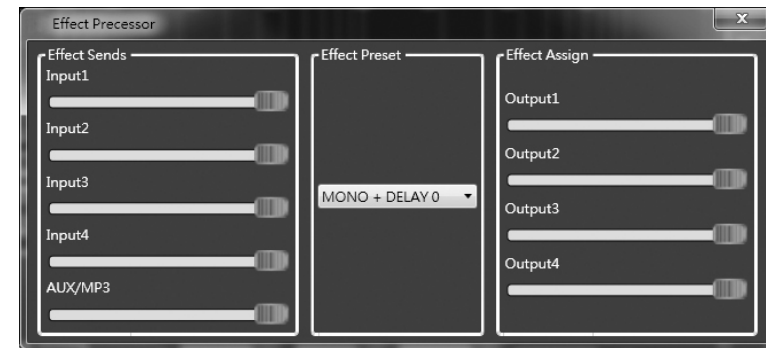

(1) You can select different effects and adjust the effect level, the higher the level, the more obvious the effect.

(2) You can adjust the input and output effects volume of each channel.

10. Routing

Can be ticked, and route 6 input to output.

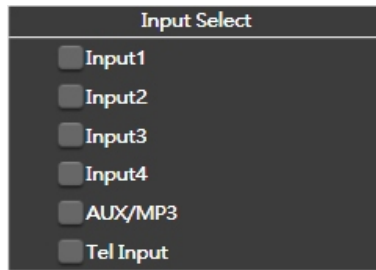

2. Subpage

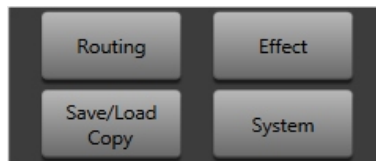

1. Routing setting

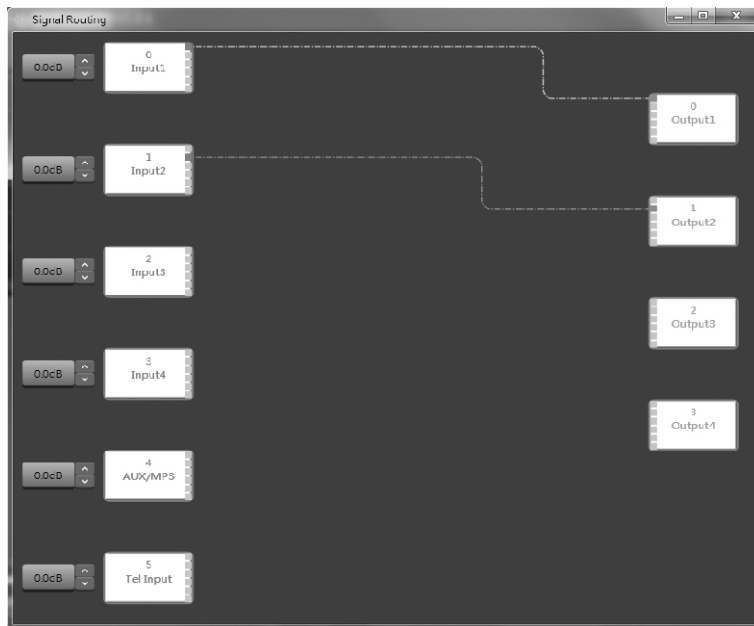

(9) AUX IN

It is used for AUX input

(10) PRE OUT/AMP IN

Jacks AMP IN and PRE OUT insert and audio unit for signal processing

(11) OUTPUT TERMINALS

CH1, CH2, CH3, CH4 Connections for constant voltage 70v or 100v speakers

OUTPUT TERMINALS: CH1, CH2, Connections for constant voltage 70V or 100V speakers

(12) 70V/100V SELECT SWITCH

It is turned to right for 70v OUTPUT TERMINALS output 70v, turned to left for 100v OUTPUT TERMINALS output 100v

(13) TELEPHONE LEVEL

It controls the level of telephone level

MP3 PLAYER

MP3 PLAYER(with USB, SD/MMC cards)

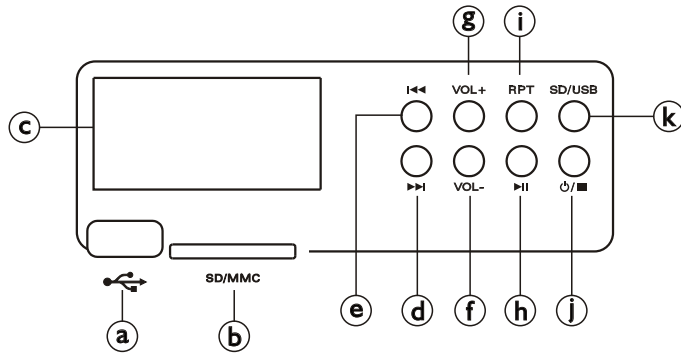

a	USB CONNECTOR	Insert USB player
b	SD/MMC CARD CONNECTOR	Insert SD/MMC Card
c	DISPLAY	Display the status of USB playing
d	▶▶	Play the next title
e	◀◀	Play the last title
f	VOL-	Press this key to decrease the sound level.
g	VOL+	Press this key to increase the sound level.
h	▶	Press this key to start to play
i	RPT	Press this key to repeat the title
j	⏻/■	Press this key to switch the power or stop the title
k	SD/USB	Press this key to select the SD Card or USB Player

7.Chime: Press it and will send out four rhythmic Chimes.

Other functions are temporarily uncontrollable at this moment, the chime volume take the volume of the output volume control knob when turn on as standard.

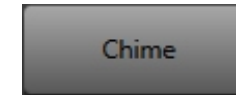

8.Press and will give an siren during which other functions are temporarily out of control,siren volume can be adjusted by the output volume control knob.

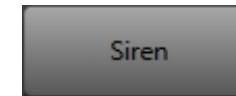

9.Compressor

Set compressor parameters for each output on this page. The compressor compresses and outputs signals above the "Threshold" at the specified rate.

-THRES

Set the compression "threshold" for the selected channel. When the signal amplitude exceeds the "threshold", the compressor will work, compress signal level which is larger than this value; when the signal is less than this limit value, it will not start the compression processing module, and the input signal will output directly.

-RATIO

Set the slope of the compression, which is the ratio of the output level to the input level. For example, if the ratio is set to 4: 1, any signal above the "Threshold" will be compressed at 4: 1. This means: that for signals above the "Threshold", the compression output increases by only 1 dB for every additional 4 dB.

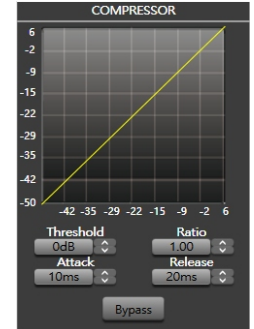

-ATTACK

Set the compression starting speed of the selected channel. Start to set the speed at which the compression will work on the signal.

-RELEASE

Set the compression release time for the selected channel, how long it takes to set the signal below the "Threshold" to its normal gain.

3. Volume adjust

It is used to adjust the volume.

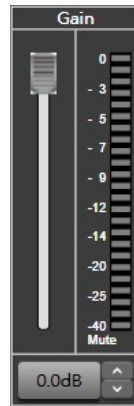

4. Volume adjust

Delay adjust, it is used to set the output delay time.

Note: Only the first parameter's value can be changed when setting (that is delay time), the other two parameters are the delay distance, expressed as (meters) and (feet), respectively, vary over time, the formula is: distance = sound speed * time.

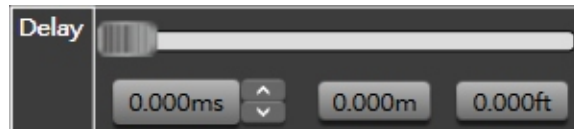

5. Invert adjust (Phase reverse)

This button is used to set the phase reverse of the output signal.

It can be used to correct the inverted audio signal and cancel or enhance each other.

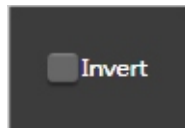

6. Mute button

This button is used to mute the output.

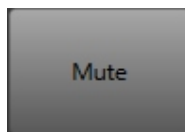

INTERFACE

I. DA-24IT/DA-24IF Interface

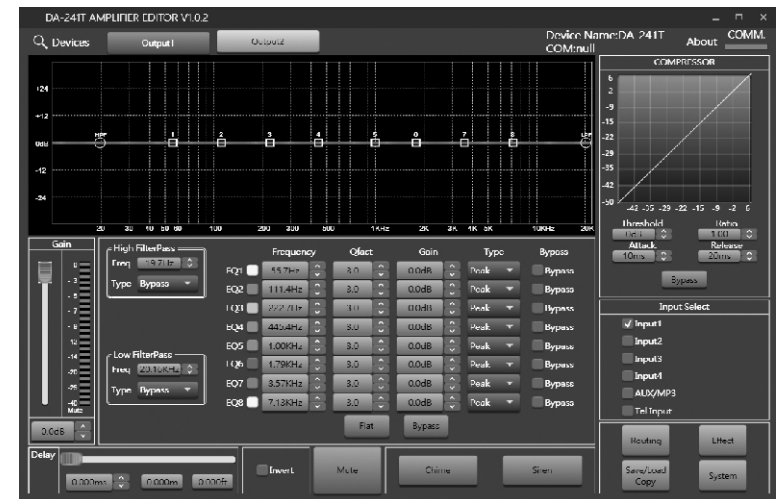
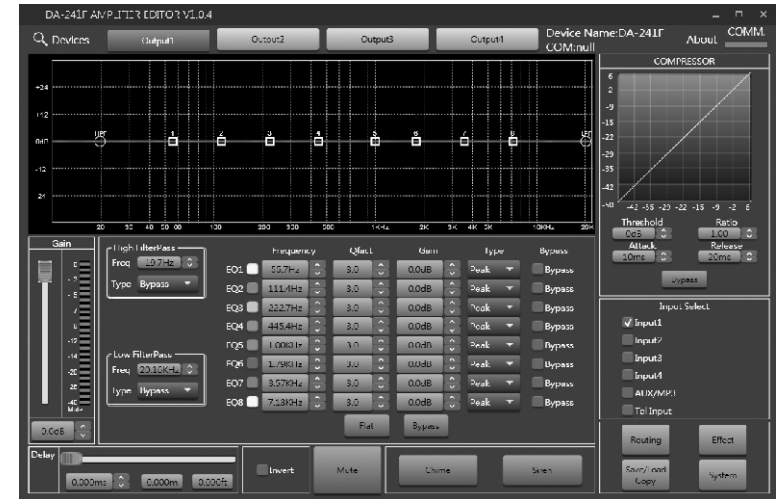

(1) Click here to research the devices

(2) Click the device to connect



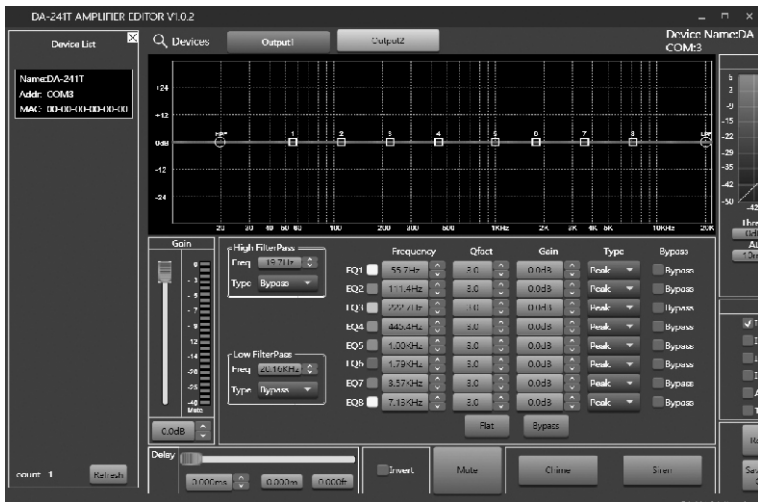
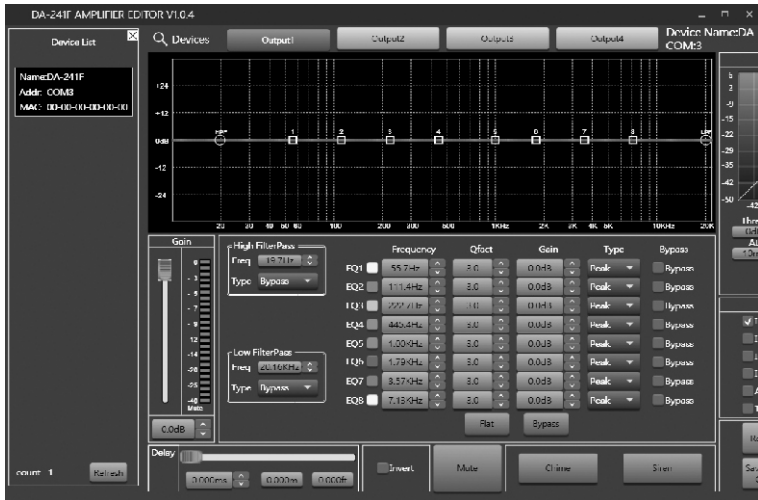

(3)The indicator will turn to green when the connection is successful. And display the device name and the connected port.

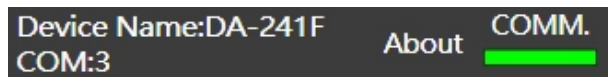

1. Select output channel 1 ~4



Select output channel 1 or 2



2. EQ and H/LFP parameter adjust

Set the output EQ parameters on this page. EQ is the compensation and correction of the frequency characteristics, so that it can reach a more flat frequency response.

-FREQ

Center frequency is the midpoint of the frequency that can pass, between the lower and higher shutdown frequency (used to define the frequency range).

-Q value

The Q value is the ratio of the center frequency and the bandwidth. If the center frequency is constant, the bandwidth is inversely proportional to Q, that is the Q value increased and the bandwidth narrowed.

-GAIN

Set the center frequency gain attenuation or enhancement, when this value is 0, the center frequency and Q value are invalid.

