

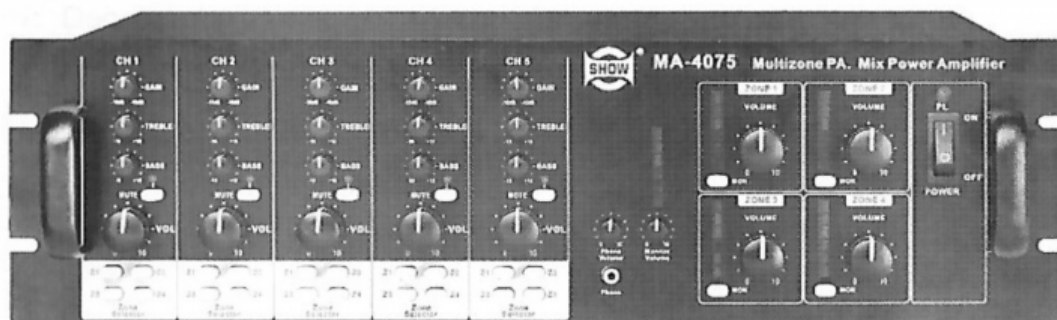

®

MULTIZONE PA. MIX POWER AMPLIFIER

MA-4075



MULTIZONE PA. MIX POWER AMPLIFIER

User's Manual

www.show-pa.com

IMPORTANT!

**Please read this manual carefully before operating
this unit for the first time.**

All rights reserved to SHOW. All features and content might be changed without prior notice. Any photocopy, translation, or reproduction of part of this manual without written permission is forbidden.

SAFETY RELATED SYMBOLS



This symbol, wherever used, alerts you to the presence of un-insulated and dangerous voltages within the product enclosure. These are voltages that may be sufficient to constitute the risk of electric shock or death.



This symbol, wherever used, alerts you to important operating and maintenance instructions. Please read.



Protective Ground Terminal



AC mains (Alternating Current)



Hazardous Live Terminal

ON: Denotes the product is turned on.

OFF: Denotes the product is turned off.

WARNING

Describes precautions that should be observed to prevent the possibility of death or injury to the user.

CAUTION

Describes precautions that should be observed to prevent damage to the product.



Disposing of this product should not be placed in municipal waste and should be separate collection.

WARNING

• Power Supply

Ensure that the mains source voltage (AC outlet) matches the voltage rating of the product. Failure to do so could result in damage to the product and possibly the user.

Unplug the product before electrical storms occur and when unused for long periods of time to reduce the risk of electric shock or fire.

• External Connection

Always use proper ready-made insulated mains cabling (power cord). Failure to do so could result in shock/death or fire. If in doubt, seek advice, from a registered electrician.

• Do not Remove any Covers

Within the product are areas where high voltages may present. To reduce the risk of electric shock do not remove any covers unless the AC mains power cord is removed.

Covers should be removed by qualified service personnel only.

No user serviceable parts inside.

• Fuse

To prevent fire and damage to the product, use only the recommended fuse type as indicated in this manual. Do not short-circuit the fuse holder. Before replacing the fuse, make sure that the product is OFF and disconnected from the AC outlet.

• Protective Ground

Before turning the product ON, make sure that it is connected to Ground. This is to prevent the risk of electric shock.

Never cut internal or external Ground wires. Likewise, never remove Ground wiring from the Protective Ground Terminal.

• Operating Conditions

Always install in accordance with the manufacturer's instructions.

To avoid the risk of electric shock and damage, do not subject this product to any liquid/rain or moisture. Do not use this product when in close proximity to water.

Do not install this product near any direct heat source.

Do not block areas of ventilation. Failure to do so could result in fire.

Keep product away from naked flames.

• **Servicing**

Refer all servicing to qualified service personnel only.

Do not perform any servicing other than those instructions contained within the User's Manual.

IMPORTANT SAFETY INSTRUCTIONS

Read these instructions

Follow all instructions

Keep these instructions. Do not discard.

Heed all warnings.

Only use attachments/accessories specified by the manufacturer.

• **Power Cord and Plug**

Do not tamper with the power cord or plug. These are designed for your safety.

Do not remove Ground connections!

If the plug does not fit your AC outlet seek advice from a qualified electrician.

Protect the power cord and plug from any physical stress to avoid risk of electric shock.

Do not place heavy objects on the power cord. This could cause electric shock or fire.

• **Cleaning**

When required, either blow off dust from the product or use a dry cloth.

Do not use any solvents such as Benzol or Alcohol.

For safety, keep product clean and free from dust.

The Front panel

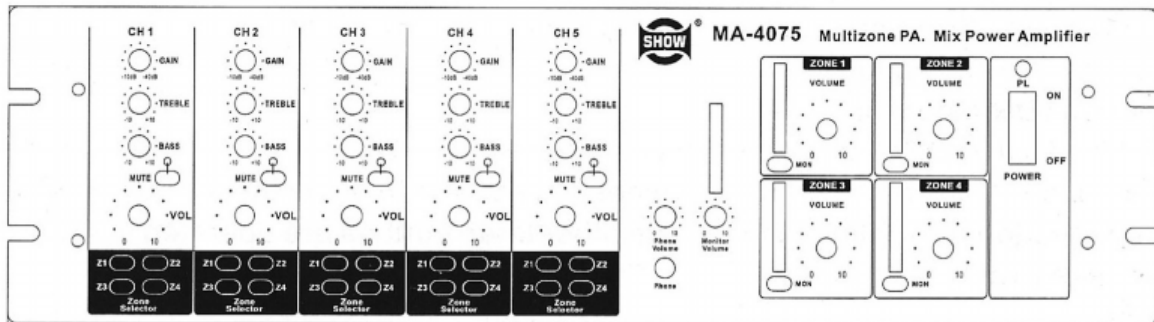

1. Gain knob

this knob controls input gain. Turn the knob clockwise, then the input increases. Turn the knob counter-clockwise, then the input decreases.

2. High knob

This is the treble control. You can use it to get rid of high frequency noises or to boost the sound of cymbals or the high harmonics of the human voice. The gain range goes from -10dB to 10dB with the central frequency 10kHz.

3. Low knob

This is the Bass control. Boost male voice or kickdrum and bass guitar. Your system will sound much bigger than what it is. The gain range goes from -10dB to +10dB and the center frequency is 100 Hz.

4. Mute

It mutes the signals from the corresponding channel.

5. Mute LED

When the mute key is pressed down, mute LED lights up, and vice versa.

6. VOL knob

This knob controls volume. Turn the knob clockwise, and the volume increases. Turn the knob counter clockwise, and the volume decreases.

7. Zone selector

Z1, Z2, Z3, Z4 can be considered as signal assignment switches. Press the button Z1 down and signal will be assigned to ZONE 1. Release the button and it stops Assigning signal to ZONE1. Z2, Z3, Z4 can be operated in the same way.

8. Phone Volume

This knob controls the volume of Phone (refer to 7). Turn the knob clockwise, and it increases the volume, and vice versa.

9. Phone

The signals of amplifier can be sent to a pair of headphones through this socket.

10. Monitor Volume

This knob controls the output signal level to monitor output.

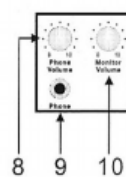
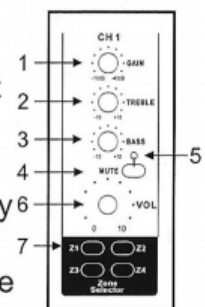

11. Zone1 VOLUME

VOLUME controls the output signal level of ZONE1.

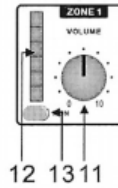

12. LED VU-meter

This stereo 6 segment LED-meter indicates the level of the overall output signal.

13. MONITOR selector

Push MONITOR button down, then it connects the signal from amplifier 1 to monitor volume. Release the button, then it cuts off the signal connection to monitor volume. The other three buttons are operated in the same way.

14. PL

This LED is the power indicator. When the amplifier is powered on, this LED lights up. When the amplifier is powered off, this LED lights off.

15. Power switch

When the switch is set in the position ON, the unit is powered on. When the switch is set in the position OFF, the unit is powered off.

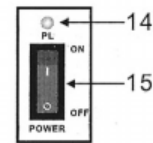

The Rear Panel

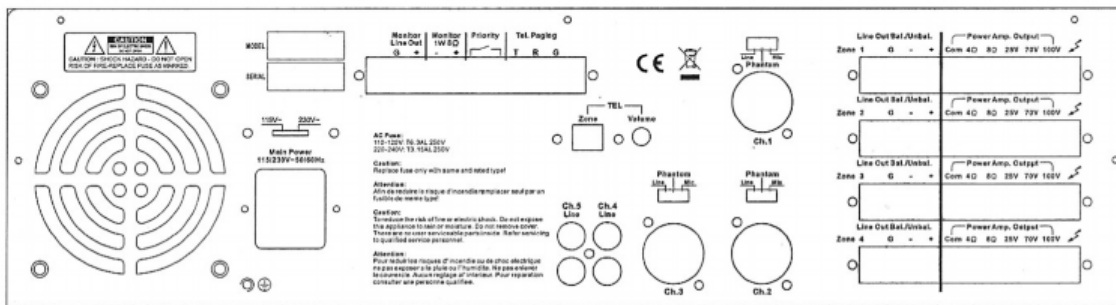

16. Intelligent fan

This is an intelligent fan. When the temperature is below 50°C, the fan stops running. When the temperature is above 50°C, it starts to run and the fan increases running speed as the temperature is rising.

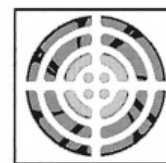

16

17. AC Input

This inlet connects the unit with the main power.

18. AC fuse

The fuse protects the alternating current circuit of the unit, and the fuse can only be replaced in the event of fuse damage.

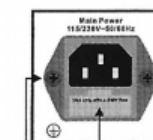

17 18

19. AC Voltage Selector

When the AC Voltage Selector is set to the left 115V, it selects the power at 100V to 127V. When the AC Voltage Selector is set to the right 230V, it selects the power at 220V to 240V.

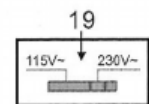

20. Monitor Line Out

Monitor Line Out can be connected with other appliance, such as amplifier, recorder, etc.

21. Monitor 1W8Ω

The terminal is meant for the connection of a small external loudspeaker that gets driven by an internal auxiliary power amplifier, providing a nominal output 1Watt. Only the mixed audio signal coming from "AUX IN" are included in the outputted signal. In addition, the output signal is controlled only by the volume control of the "CH4", "CH5", music signal level control.

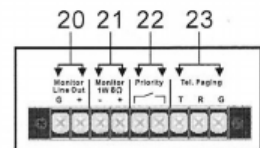

22. "Priority" Terminal.

When these terminals are short-circuit (i.e. By means of using an electrical switch), the audio signals coming from "CH2", "CH3", "CH4", "CH5", are attenuated; when the short-circuit are removed all the signals appear again.

23. Input "AUX Paging"

The terminals input lets you connect to an auxiliary signal. The input features "Voice Priority" function, which overrides all other input signals once, an auxiliary message is sent. If you want to have this function disabled forever, please contact a distributor.

24. a. Zone

There are four dip switches here. Push the dip switch up, it switches off and vice versa.

b. Volume

It controls the volume of sound source that is connected to the "Tel Paging". Turning the knob clockwise

increases the volume of the corresponding source. It is recommend to leave the control of momentarily not used input at their minimal setting "0".

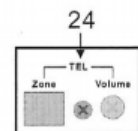

25. "LINE IN" inputs

an audio source with a high level output signal, such as an AM/FM tuner, a cassette deck, a CD player, etc. Use input sensitivity switch suitable for difference appliances. They are able to take RCA-type coaxial connectors, and unbalanced signals.

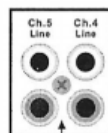

26. The mono MIC/LINE channels

These are the channels from Channel1 to Channel4. You can connect balanced, low impedance microphones to the XLR socket. On the 1/4" phone jack you can connect either a microphone or a line level instrument. You shall never connect an unbalanced microphone to the XLR socket if you do not want to damage both the Microphone and the Mixer.

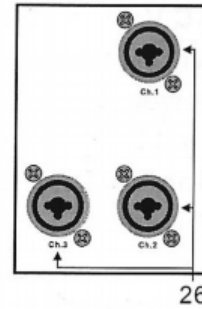

27. Ch1, CH2, CH3 and inputs sensitivity and XLR phantom switch

By turning the switch onto the "LINE" position the CH1, Ch2, Ch3 input can be connected to an audio source with high level signal output. By turning these switches onto the MIC position, CH1, CH2, Ch3 input can be connected to a dynamic microphone with low impedance. By turning the switch onto the "Phantom" position it connects phantom supply for XLR pin2 and pin3 of CH1, CH2, Ch3, which is necessary to operate condenser microphone which requires this type of external supply. It is recommended to use this switch with the general volume set on minimum.

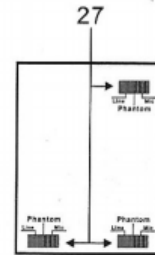

28. Line Out Bal/Unbal

These terminals can be connected with other appliance, such as amplifier, recorder, etc.

29. Power Amp Output

These terminals allow connecting speakers.

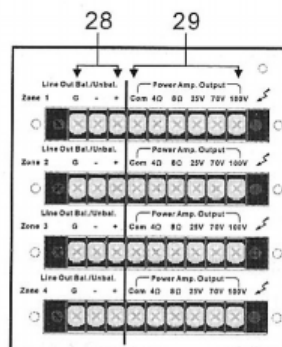

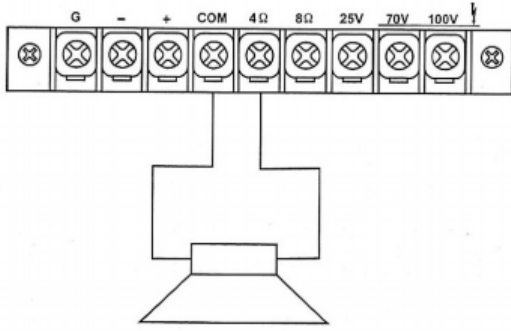

Total impedance: 4 ohms

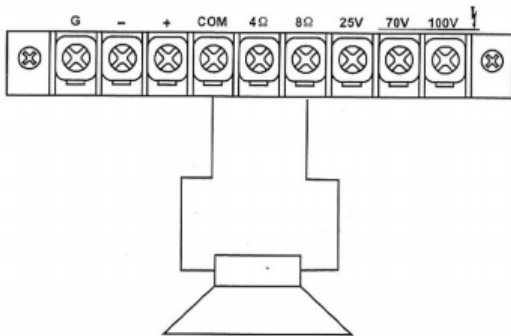

Total impedance: 8 ohms

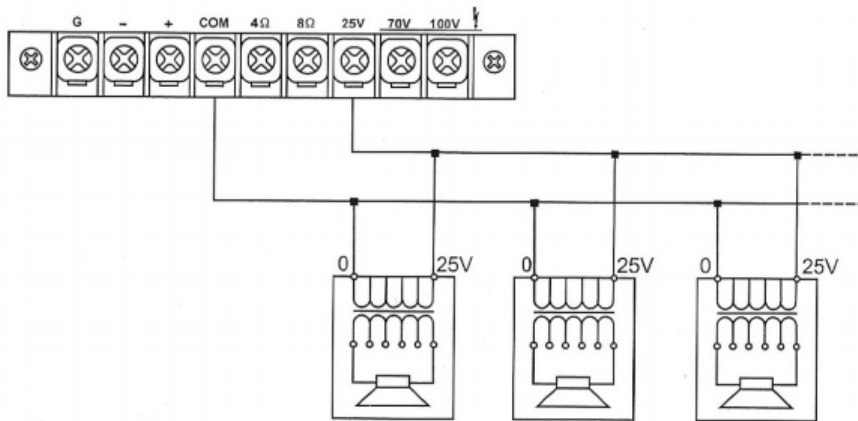

Connecting the speakers with 25V output

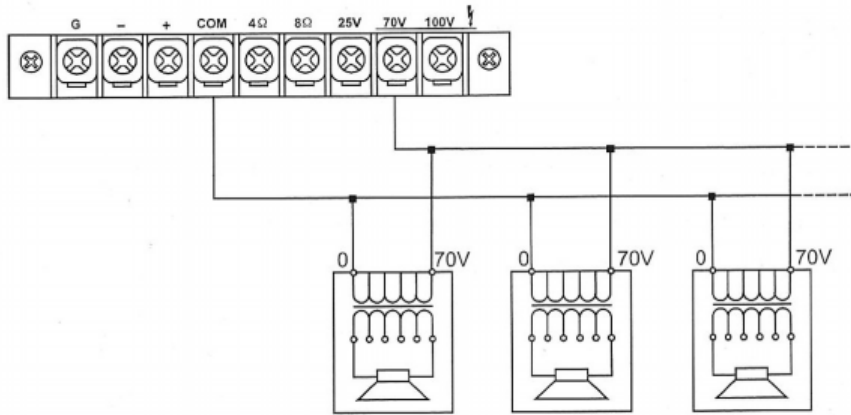

Connecting the speakers with 70V output

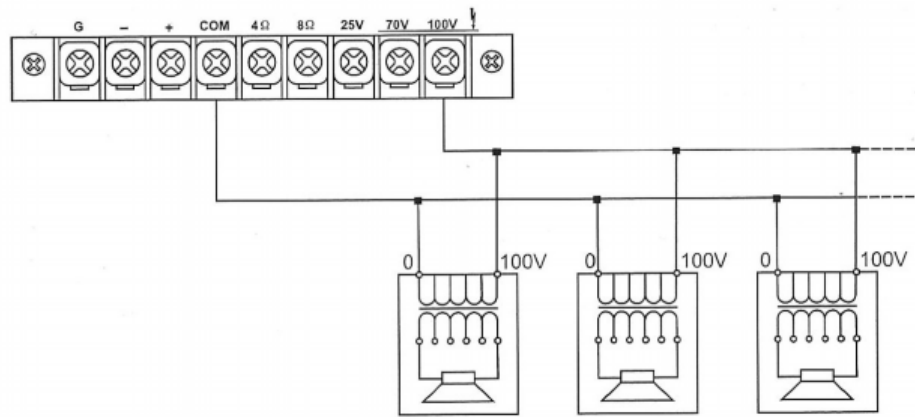

Connecting the speakers with 100V output

INSTALLATION NOTES

At all times, the amplifier has to be operated under appropriate conditions. This includes that the operation location provided sufficient ventilation and the device can not be exposed to direct sunlight or the direct radiation or reflection from any heat source. Installing the loudspeaker systems choose a location that gets not affected by extreme and /or constant vibration or other mechanical oscillation. Also make sure that the speakers are installed at locations that are free from dust and /or moisture.

CAUTION

We strongly recommend that you leave the connection of the appliance to the qualified and experienced service technician who is specialized in connecting electrical and electronic equipment. Do not take the risk of Electro-shock hazard. To reduce the risk of Electro-shock, all connections have to be accomplished before it is permissible to connect the amplifier with the main supply. Before connecting the appliance to the mains supply, once again make sure that all connections are carried out correctly and that no short-circuit exist. The overall sound reinforcement installation has to be in accordance to the laws, regulations, standards, and guidelines that are relevant and applicable in that country where the equipment is going to be operated.

AC POWER SUPPLY

CAUTION

Before using the amplifier for the first time, make sure that the appliance voltage is correct. Connect the amplifier only to grounded mains outlets. Connecting the amplifier to the mains supply (115/230Vac) has to be accomplished by inserting the supplied mains cord into the corresponding socket.

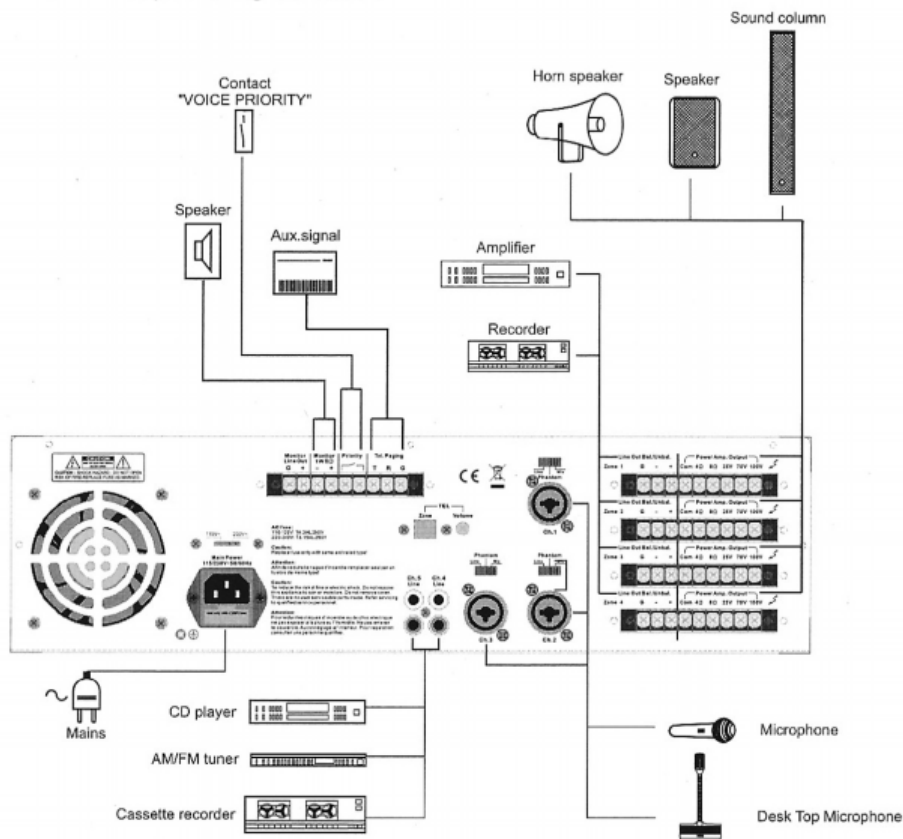

SPECIFICATION

Model:	MA-4075
Output power capacity:	RMS:40Wx4; Peak output: 90Wx4
Frequency response:	50-17000Hz (-3dB)
Total harmonic distortion:	Less than 0.5%(1KHz-nominal power capacity)
Signal/noise ratio:	Microphone: Better than 55dB rated output
	Line: better than 60dB rated output
Inputs / sensitivity-impedance:	CH1-3/XLR and 6.3mm combination socket: bal/unbal Mic: -42dB/-38dB-600ohm, bal/unbal. Line: -26B/-20dB-15Kohm, bal/unbal. LINE IN/ stereo RCA jack/ unbalanced CH4: -10dB 50Kohm CH5: 0dB 50Kohm
Tone controls:	Bass ± 10 dB-100Hz Treble ± 10 dB-10KHz
Outputs for speakers / Ohms:	4 ohm, 8 ohm
Outputs for speakers / Volts:	25V-70V-100V
Monitor output:	1Wrms
Phone output:	0.5W into 47ohm
Line out:	1.2V
Controls:	5 Gain controls for Ch1-5, 7 Volume controls for Ch1-5, tel.pagina, monitor, phone 4 Master volume control 5 Treble controls 5 Bass controls 5 Mute controls 4 Zone select switch for each channel 4 Zone monitor select switch. 1 AC select switch
Indicator:	Power indicator 4 Zone output-level meter 1 Monitor output-level meter 5 Mute indicators
Power supply/ Consumption:	115/230 Vac ($\pm 5\%$) -60/50Hz /400VA
Dimensions:	483mm(W) x 132mm(H) x 310mm(D)

Note: Specification, design and appearance are subject to change without prior notice!

SEIKAKU TECHNICAL GROUP LIMITED
No.1, Lane 17, Sec. 2, Han Shi West Road, Taichung, 401 TAIWAN
Tel:886-4-22313737 Fax:886-4-22346757
<http://www.show-pa.com> e-mail: sekaku@sekaku.com

All rights reserved to SEIKAKU. All features and content might be changed without prior notice. Any photocopy, translation, or reproduction of part of this manual without written permission is forbidden. Copyright © 2006 SEIKAKU Group